

16519
PART 1



Call Us First!
DO NOT RETURN TO STORE.

For questions on assembly or for general inquiries, you may contact us in the following ways:
Call customer service: **1-877-743-3400**

AVOID THE WAIT!

visit us online at
help.backyardproducts.com

- Submit a help request
- Answers to frequently asked questions
- Live chat with an agent



Did you enjoy building your shed?

JOIN OUR TEAM
AND MAKE UP TO \$1,500/WEEK*

Call a Recruiter Today! 734-365-7000



Flexible schedule



No selling,
just building



Bonus incentives
available

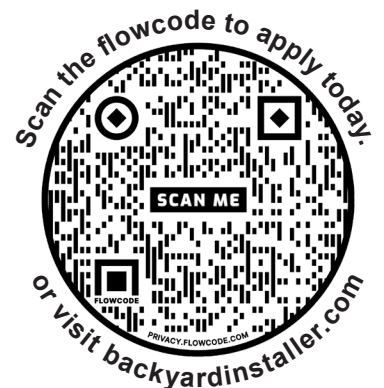

*based on number of completed installations

(This page intentionally left blank.)

PART 1

GABLE 10' x 12' (305 x 366 cm)

ACTUAL FLOOR SIZE IS 120 x 144" (304,8 x 365,8 cm)

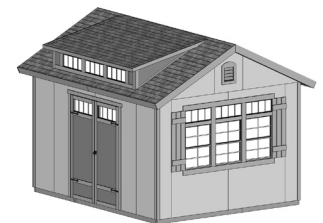
KEEP THIS MANUAL FOR FUTURE REFERENCE

DOOR LOCATION OPTION

⚠ IMPORTANT! ⚠**READ INSTRUCTIONS THOROUGHLY PRIOR TO BEGINNING ASSEMBLY.****BEFORE YOU BEGIN****• BUILDING RESTRICTIONS AND APPROVALS**

Be sure to check local building department and homeowners association for specific restrictions and/ or requirements before building.

• ENGINEERED DRAWINGS

Contact our Customer Service Team if engineered drawings are needed to pull local permits.

• SURFACE PREPARATION

To ensure proper assembly you must build your shed on a level surface. Recommended methods and materials to level your shed are listed on page 9.

• CHECK ALL PARTS

Inventory all parts listed on pages 4 - 8.

• ADDITIONAL MATERIALS

You will need additional materials to complete your shed. See page 3 for required and optional materials and quantities.

*****CONTACT OUR CUSTOMER SERVICE TEAM
IF ANY PARTS ARE MISSING OR DAMAGED*******Call: 1-877-743-3400 email: customerservice@backyardproductsllc.com**

TOOLS

Required

Phillips Screwdriver 

Drill / Driver 
 1/8" Drill Bit
 1/4" Drill Bit
 5/16" Drill Bit
 1/2" Drill Bit
 #2 Phillips Drive Bit

Hammer 

Level 

Pencil 

Tape Measure 

Square  or 

Utility Knife 

Shingle Blades 

Caulk Gun 

Paint Tools 

Safety Glasses 

Hand Saw 

Ladder 

Optional

Tool Belt/ Nail Pouch 

Tin Snips (for drip edge) 

Chalk Line 

Nail Gun 
 • gun nails

Gloves 

Safety! Always use approved safety glasses during assembly.

HELPFUL REMINDER SYMBOLS

Look for these symbols for helpful reminders throughout this manual.

 = Assistance Required; two or more people.

 = Ensure squareness.

 = Important required step or operation.

 = Helpful assembly hint.

 = Mark part with pencil.

 **BEGIN** = Beginning of steps for assembly or installation.

 **FINISH** = You have finished the assembly or installation.

 = Level

ORIENT LUMBER AND TRIM FOR BEST APPEARANCE

Framing lumber is graded for structural strength and not appearance. Exterior trim is graded for one good side.

Always install the material leaving the best edge and best surface visible. Please remember that these blemishes in no way negatively affect the strength or integrity of our product. (See Fig. A, B, C.)

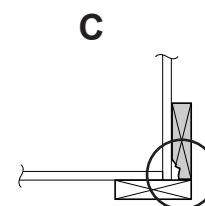
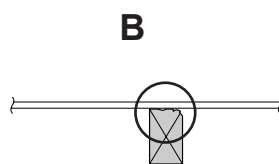
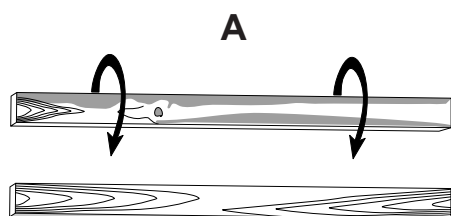

ADDITIONAL MATERIALS

FOUNDATION OR FLOOR MATERIALS

- This shed does not include leveling materials.
- See the FLOOR LEVELING section on page 9 for recommended methods and suggested materials to properly level your floor, as this will vary depending on your specific site.

COMPLETING YOUR SHED

You will need these additional materials:

3-TAB SHINGLES 7 Bundles

1" GALVANIZED ROOFING NAILS.... 4 Lbs
For shingles.

PAINT FOR SIDING 3 Gallons
Use 100% acrylic latex exterior paint. (2) coats recommended.

PAINT FOR TRIM 3 Quarts
Use 100% acrylic latex exterior paint.

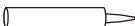
CAULK 3 Tubes
Use acrylic latex exterior caulk that is paintable. 

OPTIONAL MATERIALS

DRIP EDGE 60 Feet

#15 ROOFING FELT
To cover 196 Sq. Ft. of roof area.

1" GALVANIZED ROOFING NAILS.....1/4 Lb
For roofing felt.

REFER TO THE BACK OF THIS MANUAL AND THE MANUFACTURER'S INSTRUCTIONS FOR INSTALLATION OF SHINGLES, DRIP EDGE AND FELT.

NOTES

PARTS IDENTIFICATION AND SIZES

Part identification letters are stamped on some parts.

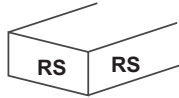

Check these locations for part stamp.

Treated lumber is stamped:

TREATED

WOOD SIZE CONVERSION CHART

| Nominal Board Size | Actual Size |
|--------------------|--------------------------------|
| 2 x 4 | 1-1/2" x 3-1/2" (3,8 x 8,9 cm) |
| 1 x 4 | 3/4" x 3-1/2" (1,9 x 8,9 cm) |
| 2 x 3 | 1-1/2" x 2-1/2" (3,8 x 6,3 cm) |
| 1 x 3 | 3/4" x 2-1/2" (3,8 x 6,3 cm) |

PARTS LIST



INVENTORY YOUR PARTS before you begin.

We suggest sorting parts by the category they are listed in.

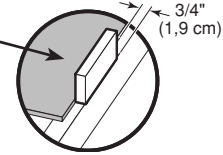

WALLS

- x1 **GAA** 1 x 3 x 5" (2,5 x 7,6 x 12,7 cm) Gauge Block for 3/4" (1,9 cm) measurement
- x1 **AMA** 2 x 4 x 7-1/2" (5,1 x 10,2 x 35,6 cm)
- x5 **COA** 2 x 4 x 8" (5,1 x 10,2 x 20,3 cm)
- x6 **AO** 2 x 4 x 22-1/2" (5,1 x 10,2 x 57,1 cm)
- x3 **RL** 2 x 4 x 24" (5,1 x 10,2 x 61 cm)
- x1 **RR** 2 x 4 x 28" (5,1 x 10,2 x 71,1 cm)
- x4 **AFC** 2 x 4 x 27-1/4" (5,1 x 10,2 x 69,2 cm)
- x4 **STL** 2 x 4 x 44-1/2" (5,1 x 10,2 x 113 cm)
- x2 **SP** 2 x 4 x 48" (5,1 x 10,2 x 121,9 cm)
- x1 **OSB** 7/16 x 3-1/4 x 58-3/4" (1,1 x 8,3 x 149,2 cm) OSB
- x2 **KMA** 2 x 4 x 59" (5,1 x 10,3 x 149,9 cm)
- x2 **SX** 2 x 4 x 60" (5,1 x 10,3 x 152,4 cm)
- x6 **YFA** 2 x 4 x 68-1/2" (5,1 x 10,2 x 174 cm)
- x29 **TK** 2 x 4 x 80" (5,1 x 10,2 x 203,2 cm)
- x2 **TO** 2 x 4 x 84" (5,1 x 10,2 x 213,4 cm)
- x3 **CTZ** 2 x 4 x 93-3/4" (5,1 x 10,2 x 238,1 cm)
- x1 **UN** 2 x 4 x 94-1/2" (5,1 x 10,2 x 240 cm)
- x2 **TP** 2 x 4 x 96" (5,1 x 10,2 x 243,8 cm)

EAVE & RAFTERS

- x2 **OSB OR WOOD GRAIN** 6" x 24" (15,2 x 61 cm) OSB OR WOOD GRAIN ⚠
- x8 **OSB OR WOOD GRAIN** 4-13/16" x 24" (12,2 x 61 cm) OSB OR WOOD GRAIN ⚠
- x4 **KDA** 2 x 4 x 2-7/8" (5,1 x 10,2 x 7,3 cm)
- x4 **GPC** 2 x 4 x 4-3/8" (5,1 x 10,2 x 11,1 cm)
- x8 **CLA** 2 x 4 x 4-7/8" (5,1 x 10,2 x 12,4 cm)
- x5 **BVT** 2 x 4 x 61-1-4" (5,1 x 10,2 x 155,6 cm)
- x8 **FLM** 2 x 4 x 73-3/4" (5,1 x 10,2 x 187,3 cm)
- x9 **DPN** 2 x 4 x 73-3/4" (5,1 x 10,2 x 187,3 cm)
- x4 **XMB** 2 x 4 x 80-5/8" (5,1 x 10,2 x 204,8 cm)

DOOR

- x4 **FA** 19/32 x 3 x 22-5/8" (1,5 x 7,6 x 57,5 cm)
- x1 **WR** 19/32 x 2-1/2 x 63" (1,5 x 6,3 x 160 cm)
- x2 **OO** 69" (175,3) Door Stiffener



FLOOR FRAMING

- x2** TREATED 2 x 4 x 24" (5,1 x 10,2 x 61 cm)
- x9** TREATED 2 x 4 x 45" (5,1 x 10,2 x 114,3 cm)
- x2** TREATED 2 x 4 x 48" (5,1 x 10,2 x 121,9 cm)
- x2** TREATED 2 x 4 x 72" (5,1 x 10,2 x 182,9 cm)
- x9** TREATED 2 x 4 x 93" (5,1 x 10,2 x 236,2 cm)
- x2** TREATED 2 x 4 x 96" (5,1 x 10,2 x 243,8 cm)

FLOOR PANELS

Floor panels are 5/8" (1,6 cm) thick.

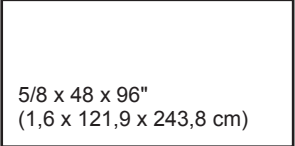

NOTE: Panel parts are not stamped.

- x1** 
 5/8 x 23-7/8 x 48"
 (1,6 x 60,6 x 121,9 cm)
- x1** 
 5/8 x 23-7/8 x 96"
 (1,6 x 60,6 x 243,8 cm)
- x3** 
 5/8 x 48 x 96"
 (1,6 x 121,9 x 243,8 cm)

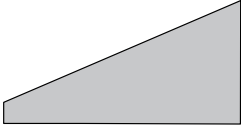
WALL PANELS / DOORS

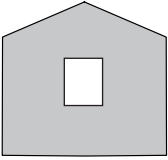
- 
 x2

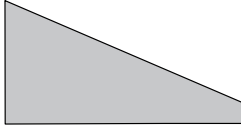

 x2

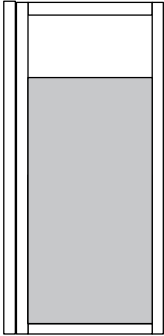

 x2
- 
 x3
 3/8 x 23-7/8 x 84"
 (1 x 60,6 x 213,4 cm)

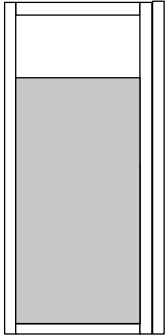

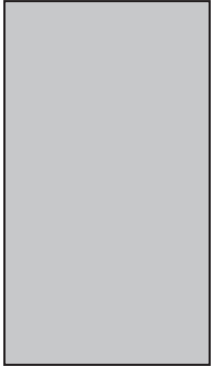
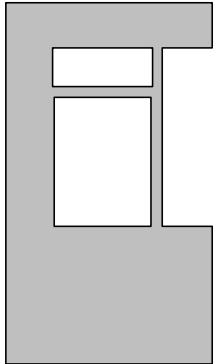
 x2
 3/8 x 11-7/8 x 84"
 (1 x 30,2 x 213,4 cm)

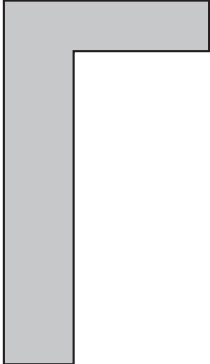

 x1
LEFT DOOR

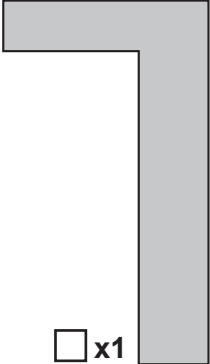

 x1
RIGHT DOOR

 x5
 3/8 x 48 x 84"
 (1 x 121,9 x 213,4 cm)
- 
 x1
 3/8 x 48 x 84"
 (1 x 121,9 x 213,4 cm)

 x1
 3/8 x 48" x 84"
 (1 x 121,9 x 213,4 cm)

 x1
 3/8 x 48" x 84"
 (1 x 121,9 x 213,4 cm)

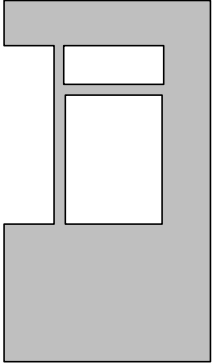

 x1
 3/8" x 2-1/2 x 23-1/4"
 (1 x 6,3 x 59,1 cm)

 x1
 3/8 x 48 x 84"
 (1 x 121,9 x 213,4 cm)

ROOF PANELS

Roof panels are 7/16" (1,1 cm) thick.

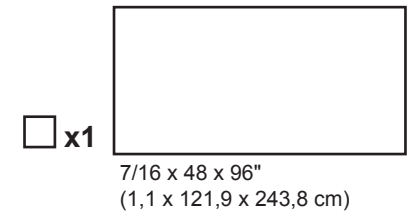
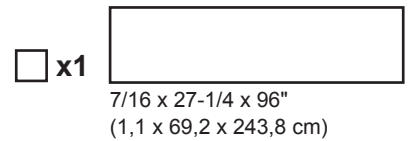
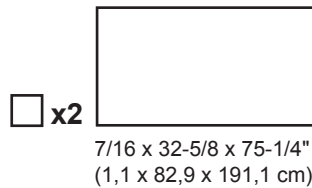
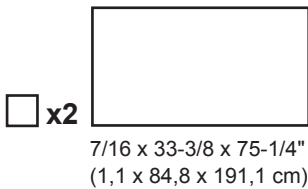
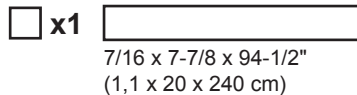
NOTE: Panel parts are not stamped.



TRIM - SOFFIT - FASCIA

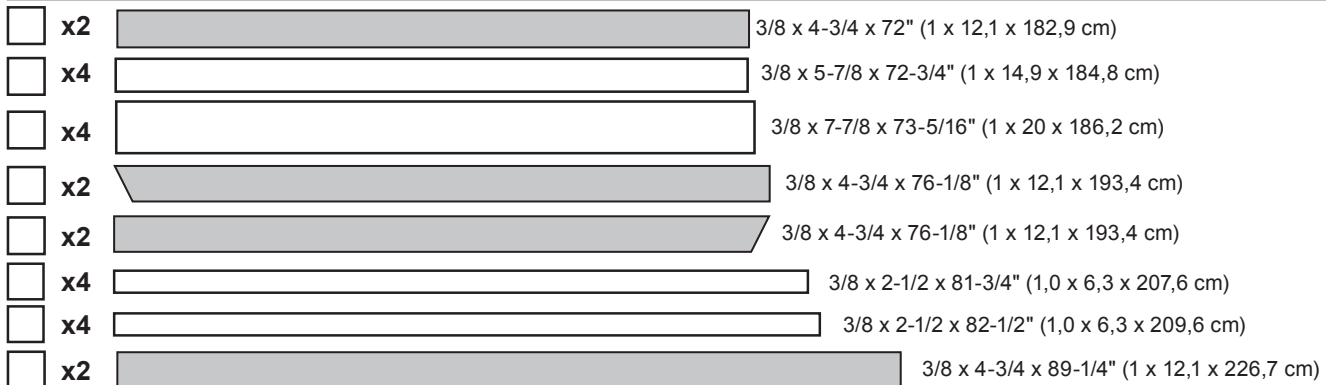

DORMER TRIM and FRAMING

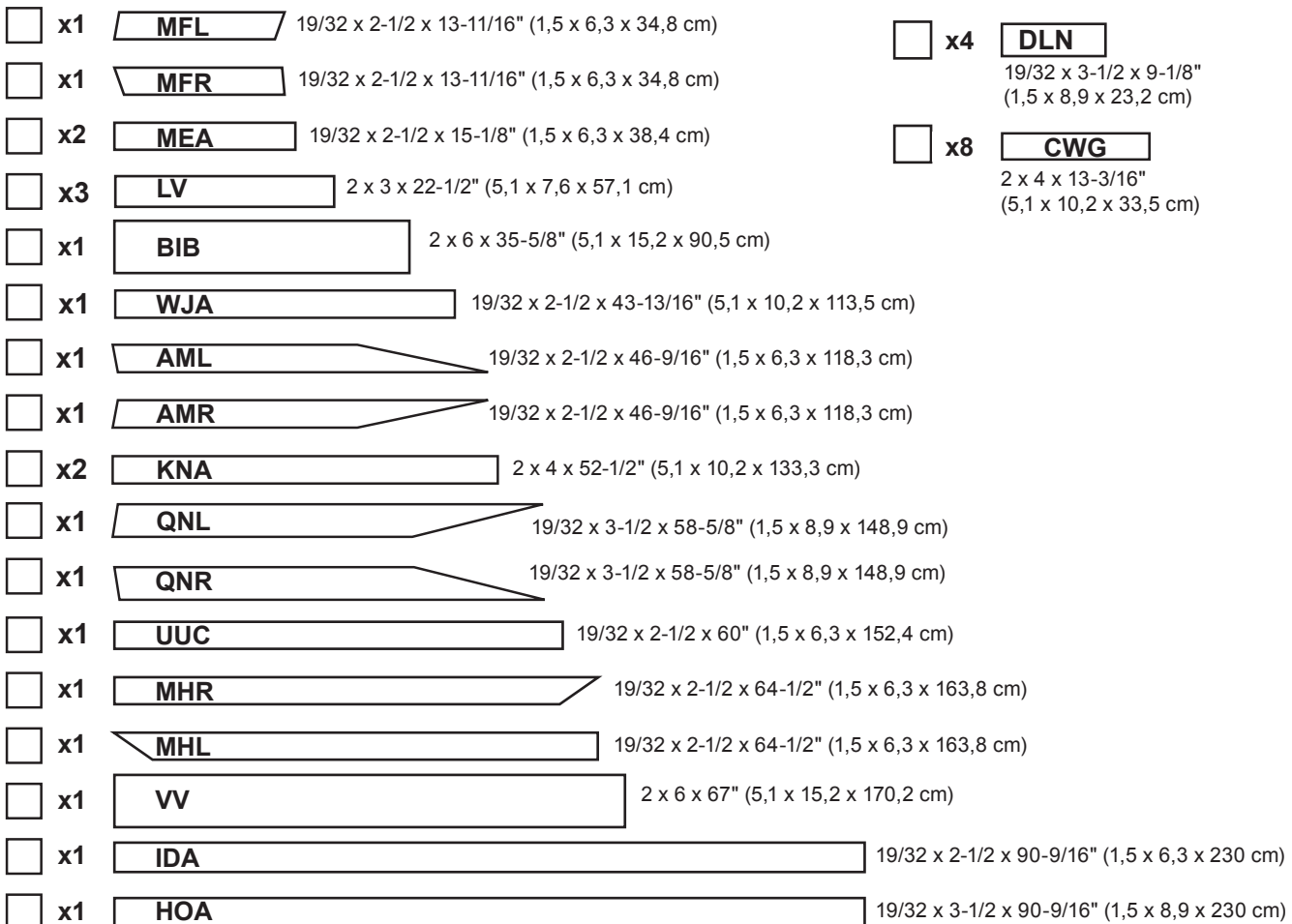

DORMER WALL PANELS

Dormer panels are 3/8" (1,1 cm) thick. **NOTE:** Panel parts are not stamped.

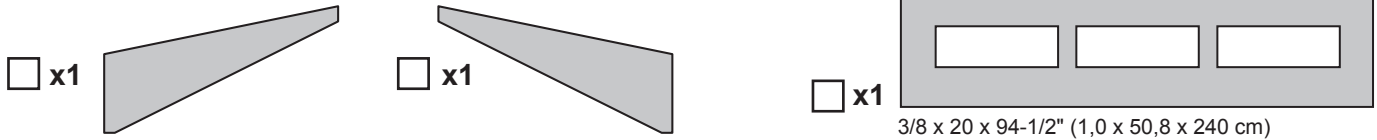

DORMER ROOF PANELS

Roof panels are 7/16" (1,1 cm) thick. **NOTE:** Panel parts are not stamped.

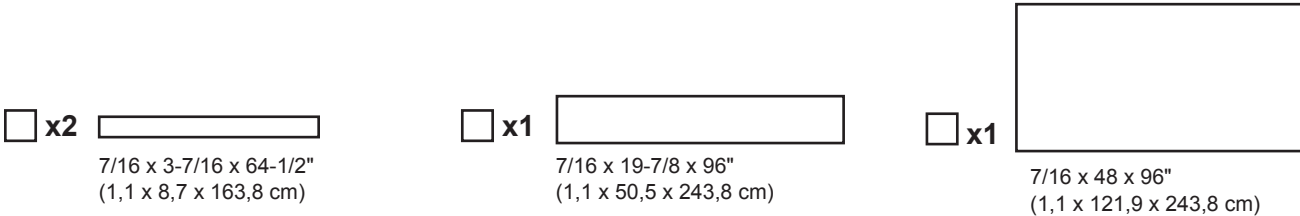

SHELF - WORKBENCH - LOFT

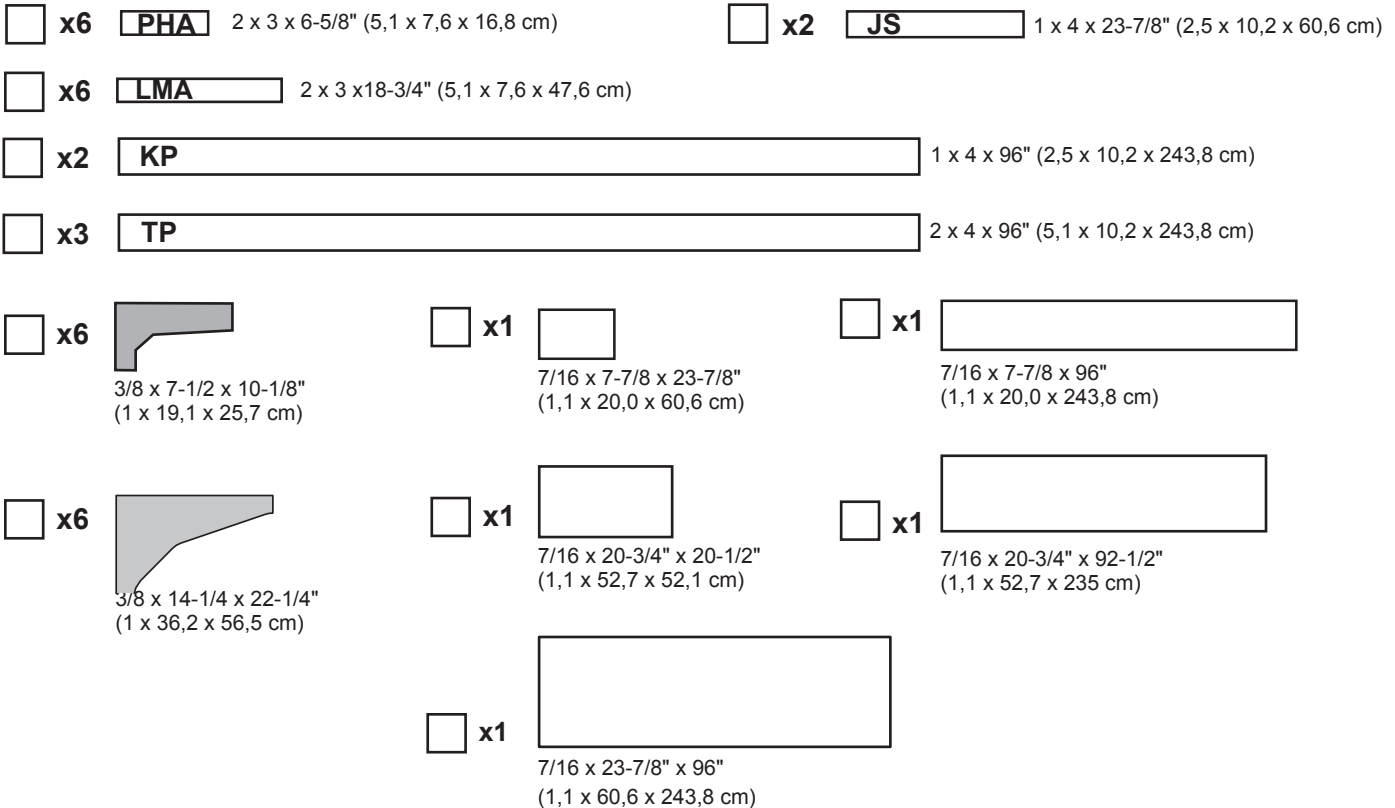

WINDOW TRIM & SHUTTERS

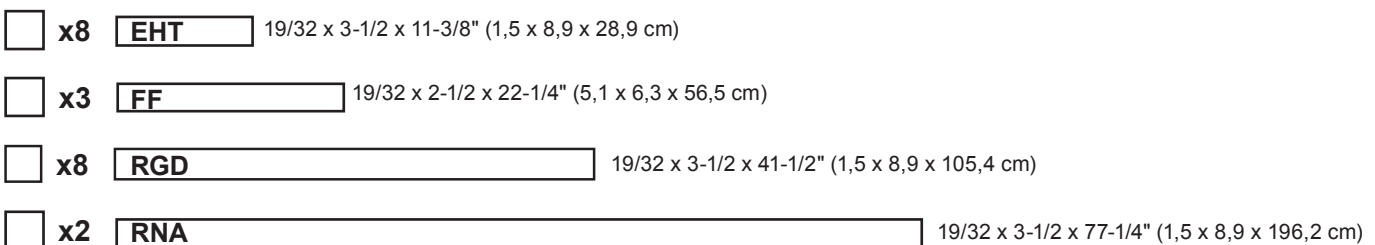





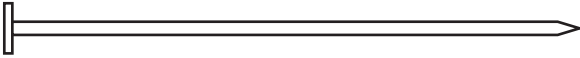
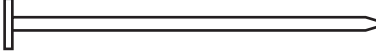

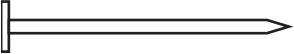

FASTENERS & HARDWARE

NAIL BOXES

- x8** BOXES  3" (7,6 cm)
- x9** BOXES  2" (5,1 cm)

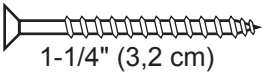
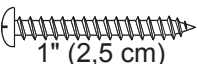
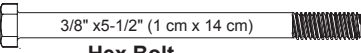
FASTENER/HARDWARE BAG

- | | |
|---|---|
| <ul style="list-style-type: none"> <input type="checkbox"/> x140  1-1/2" (3,8 cm) <input type="checkbox"/> x366  2" (5,1 cm) <input type="checkbox"/> x195  3" (7,6 cm) <input type="checkbox"/> x47  2" (5,0 cm) <input type="checkbox"/> x85  1-5/8" (4,1 cm) <input type="checkbox"/> x104  3/4" (1,9 cm) <input type="checkbox"/> x12  1" (2,5 cm) | <ul style="list-style-type: none"> <input type="checkbox"/> x25  1-1/4" (3,2 cm) <input type="checkbox"/> x8  1" (2,5 cm) <p>(NOT ACTUAL SIZE)</p> <ul style="list-style-type: none"> <input type="checkbox"/> x2  3/8" x 5-1/2" (1 cm x 14 cm) Hex Bolt <input type="checkbox"/> x4  3/8" (1 cm) Flat Washer <input type="checkbox"/> x2  3/8" (1 cm) Lock Nut |
|---|---|

VENT/ DOOR HARDWARE/ WINDOW

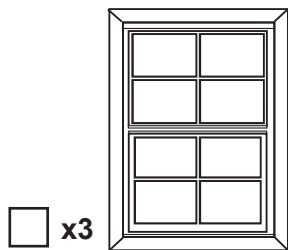

Window

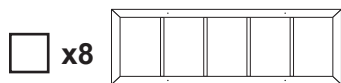
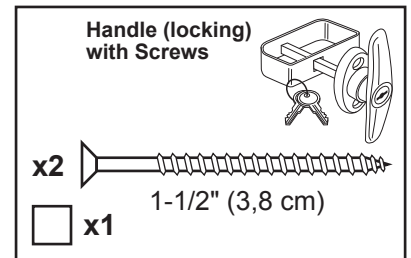
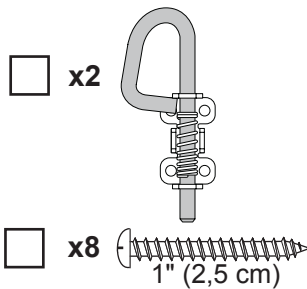

Window

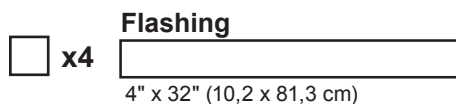
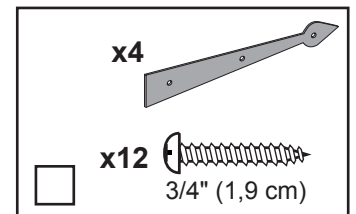
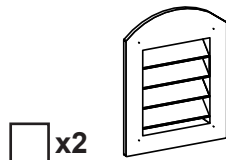

Flashing

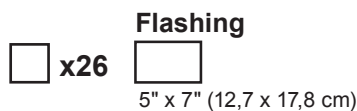

Flashing

FLOOR LEVELING OPTIONS

There are multiple ways to level your floor frame. Our recommended leveling method is shown below.
Leveling materials are not included in this kit.

PREFERRED METHOD - 4x4 TREATED RUNNERS

- 3" Screws angled into 4x4.
- (2) at each point frame and 4x4 touch.

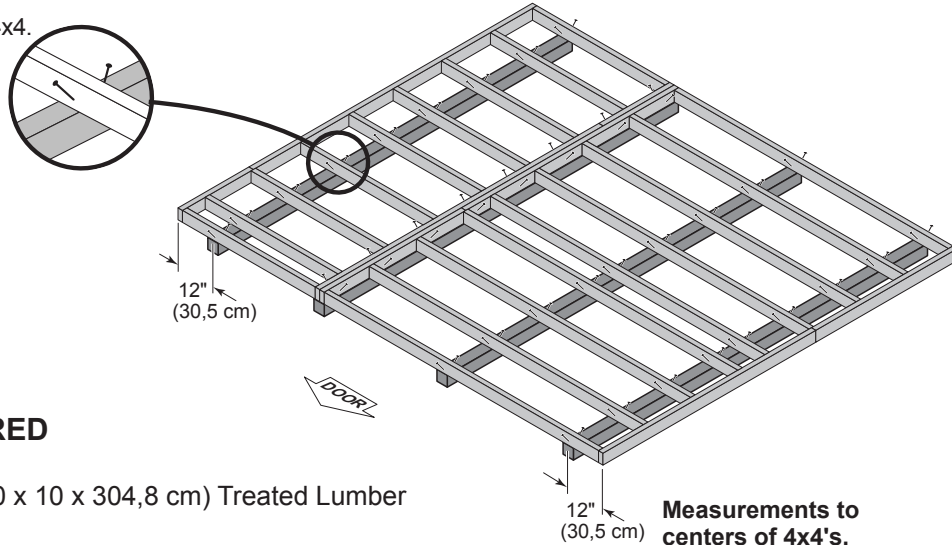

MATERIAL REQUIRED

x4 4 x 4 x 10' (10 x 10 x 304,8 cm) Treated Lumber

Fasteners for Frame to 4x4.
(3" Screws shown as one option.) Minimum (60) 3" screws / exterior grade.

Use only wood treated for ground contact and fasteners approved for use with treated wood.

Always support frame seams.

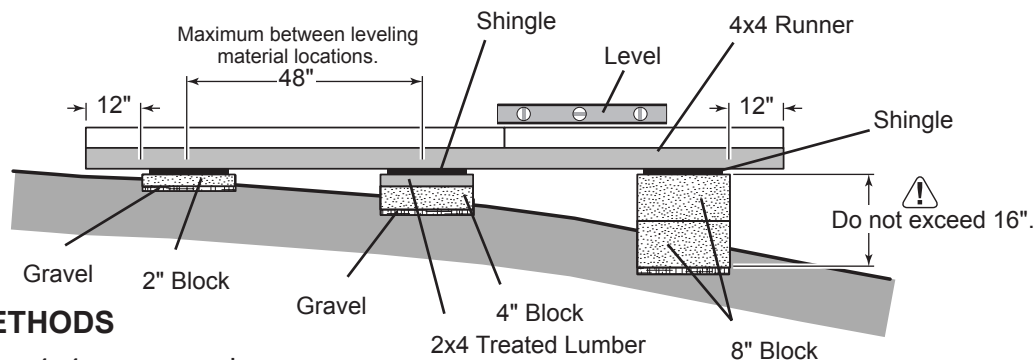

LEVELING METHODS

- Level under 4x4 runners only.
- Locate leveling material 12" from ends of runners and no more than 48" apart.
- Asphalt shingles should be used between 4x4 runners and blocks or treated lumber. Never use shingles in direct contact with ground.
- For best results and aiding in water drainage use gravel under each concrete block.

LEVELING MATERIALS

- Gravel
- Solid Masonry Blocks in 1", 2", 4" or 8" thickness
- 2x4 Treated Lumber
- Asphalt Shingles

Leveling higher than 16" not recommended.

CONCRETE

- If you are building your shed on a concrete foundation see the following page.

CONCRETE FOUNDATION

Your kit contains all materials to construct a wooden floor. If you choose to install your kit on a concrete slab refer to the diagram below.

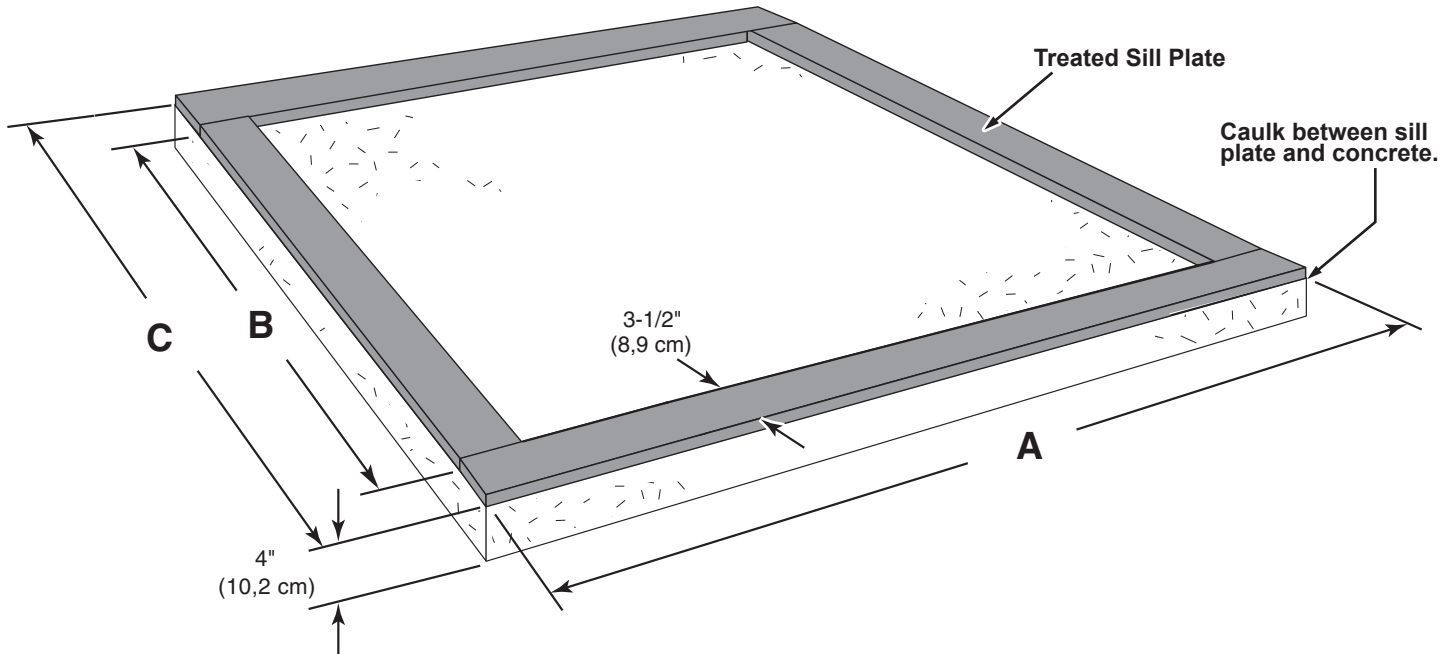

| Building Size | Actual Size | A | B | C |
|-----------------------------|--------------------------------|-----------------|---------------|-----------------|
| 10'x 12' (243,8 x 365,8 cm) | 120" x 144" (304,8 x 365,8 cm) | 120" (304,8 cm) | 137" (348 cm) | 144" (365,8 cm) |

Requires:

- x2** 2 x 4 x 12' (5,1 x 10,2 x 365,8 cm) ⚠ **MUST be treated lumber.**
- x2** 2 x 4 x 10' (5,1 x 10,2 x 304,8 cm) ⚠ **MUST be treated lumber.**
- x1** Caulk

⚠ Allow new concrete slabs to cure for at least seven (7) days.

- A treated 2 x 4 (5,1 x 10,2 cm) sill plate is required when installing your shed on concrete. **Hint: Use treated lumber in your kit or purchase full length treated lumber.**
- Use a high quality exterior grade caulk beneath all sill plates.
- Fasten 2 x 4 (5,1 x 10,2 cm) sill plates to slab using approved concrete anchors (**fasteners not included**).
- Check local code for concrete foundation requirements.

NOTES

10' x 8' FLOOR FRAME

PARTS REQUIRED:

x2  2 x 4 x 72" (5 x 10 x 183 cm) Treated Wood

x2  2 x 4 x 48" (5 x 10 x 122 cm) Treated Wood

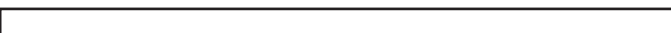
x9  2 x 4 x 93" (5 x 10 x 236,2 cm) Treated Wood

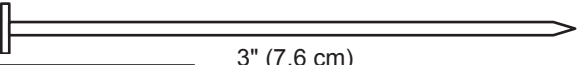
x40  3" (7,6 cm)

Look for
TREATED
Stamp

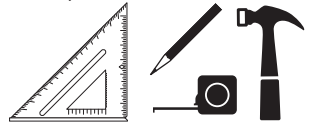

⚠ You will build two floor sections.

✓ **BEGIN**

- 1 Orient parts as shown on flat surface. Measure and mark.
Use (2) 3" nails at each mark and (4) nails at seams.

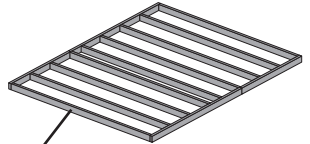

Section 1



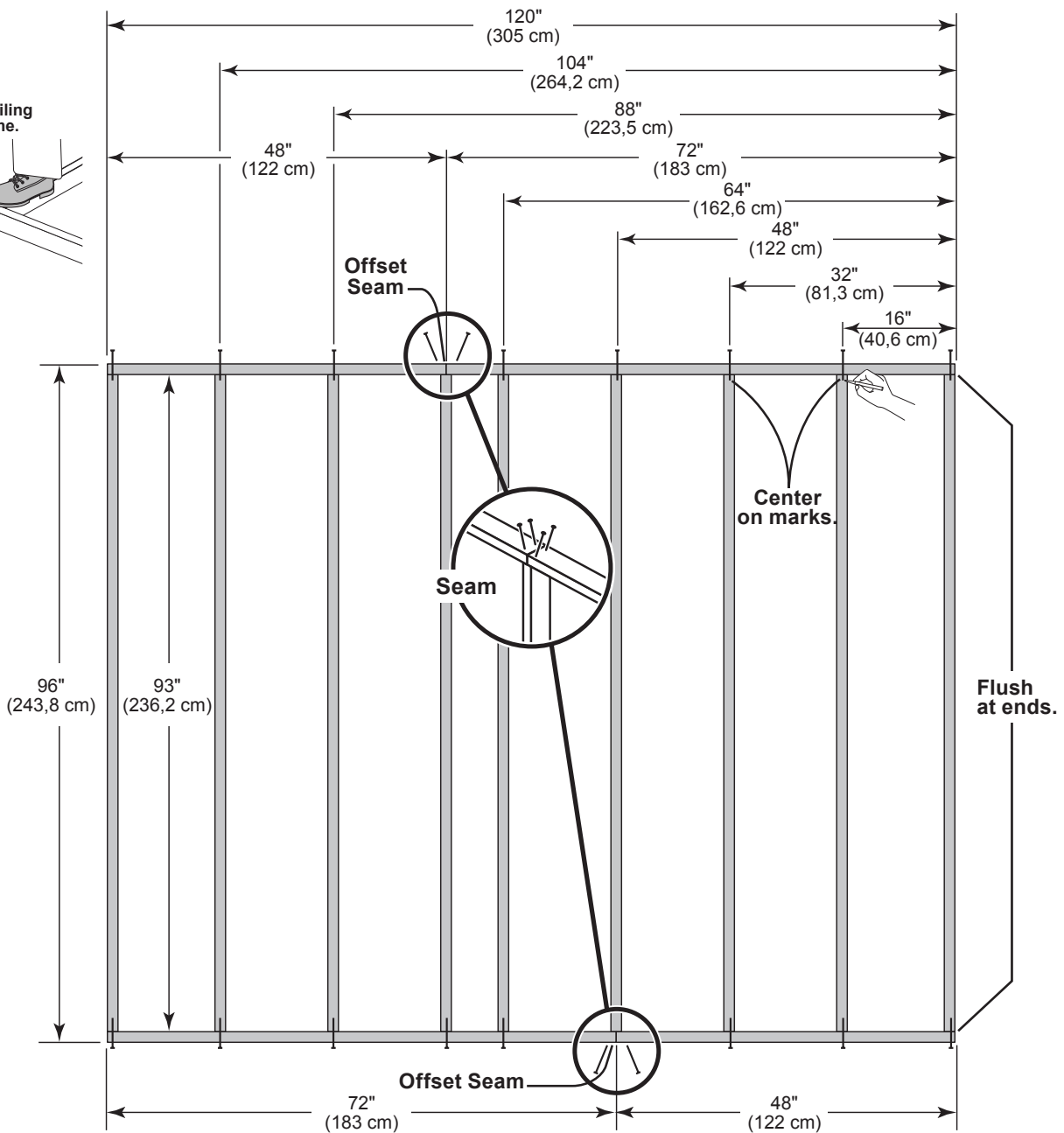
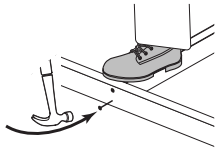

HINT:
For easier nailing
stand on frame.



10' x 4' FLOOR FRAME

PARTS REQUIRED:

x2 
2 x 4 x 96" (5 x 10 x 243,8 cm) Treated Wood

x2 
2 x 4 x 24" (5 x 10 x 61cm) Treated Wood

Look for
TREATED
Stamp

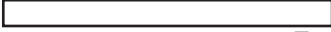
x9 
2 x 4 x 45" (5 x 10 x 114,3 cm) Treated Wood

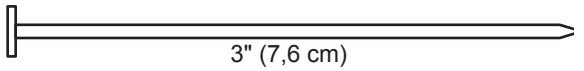
x42  3" (7,6 cm)

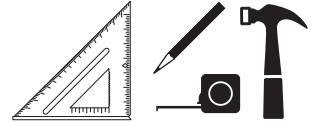

2 Orient parts as shown on flat surface to build floor section 2.
Measure and mark.

Use (2) 3" nails at each mark and (4) nails at seams.



HINT:
For easier nailing
stand on frame.

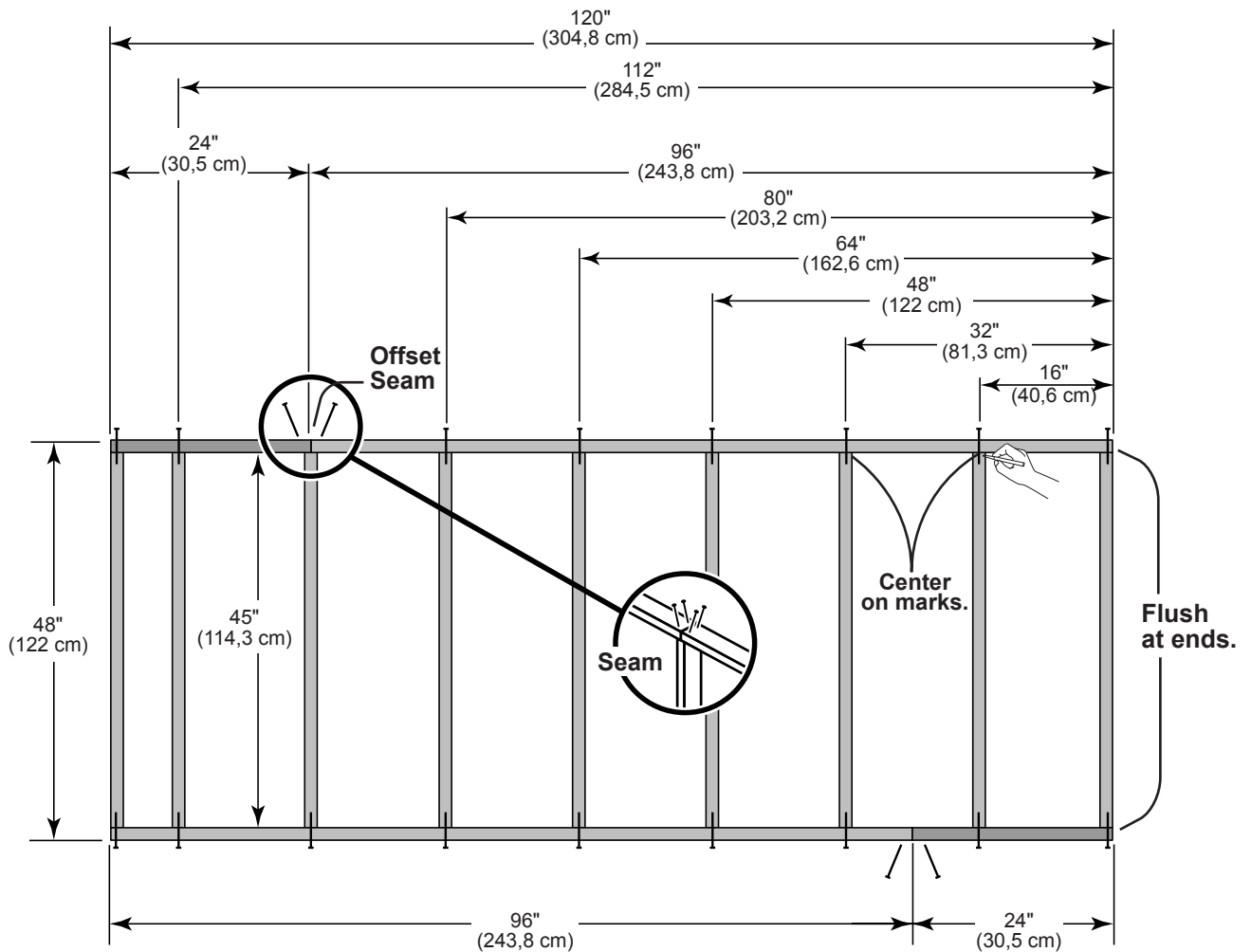
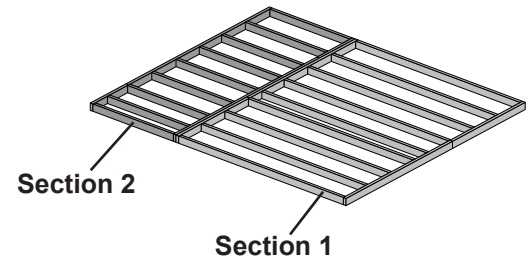
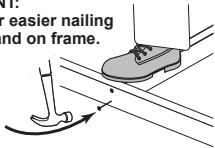

10' x 4' FLOOR FRAME

PARTS REQUIRED:

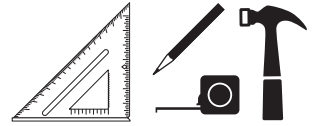
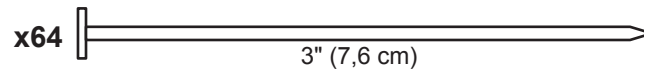

3 Fasten floor sections together with 3" nails as shown.

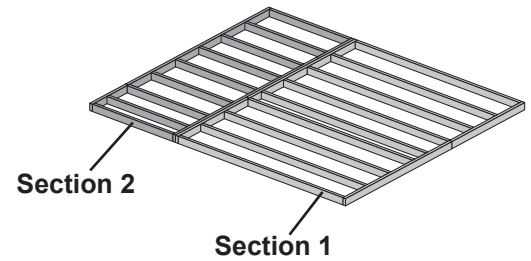

**(4) Nails per side,
stagger pattern.**

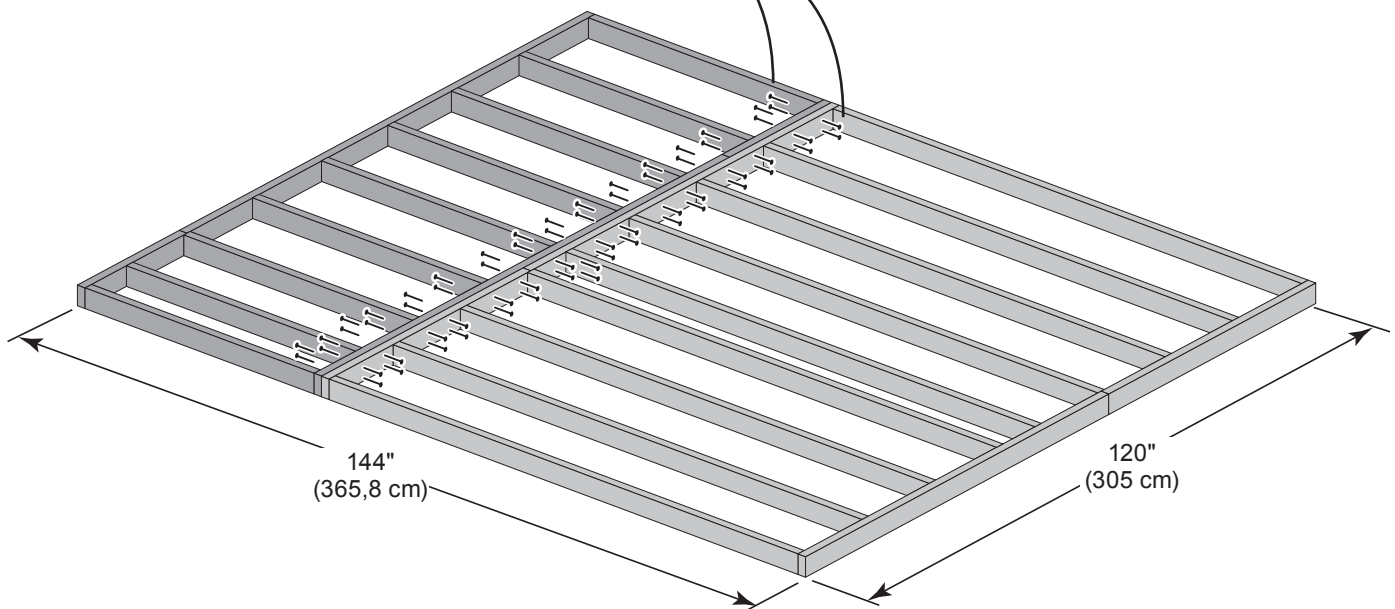

You have finished your floor frame.

Proceed to level and square the floor frame.

STOP!



LEVEL AND SQUARE FLOOR FRAME



STOP!

Before attaching floor decking, it is important to level and square the floor frame.
A level and square floor frame is required to correctly construct your shed.

✓ **BEGIN**

- 1 See page 7 for the preferred floor leveling method.
- 2 Use level and check the frame is level before applying floor panels.
- 3 Check for frame squareness by measuring diagonally across corners. If the measurements are the same, the frame is square. The diagonal measurement will be approximately 187-7/16" (476,1 cm).
- 4 When the frame is level and square secure one side of frame to the 4x4 runners using (1) fastener at ends of each runner. Move to the opposite end of the frame. Secure the frame to 4x4 runners with (1) fastener at ends of each runner making sure the frame remains square (**Fig. A**).

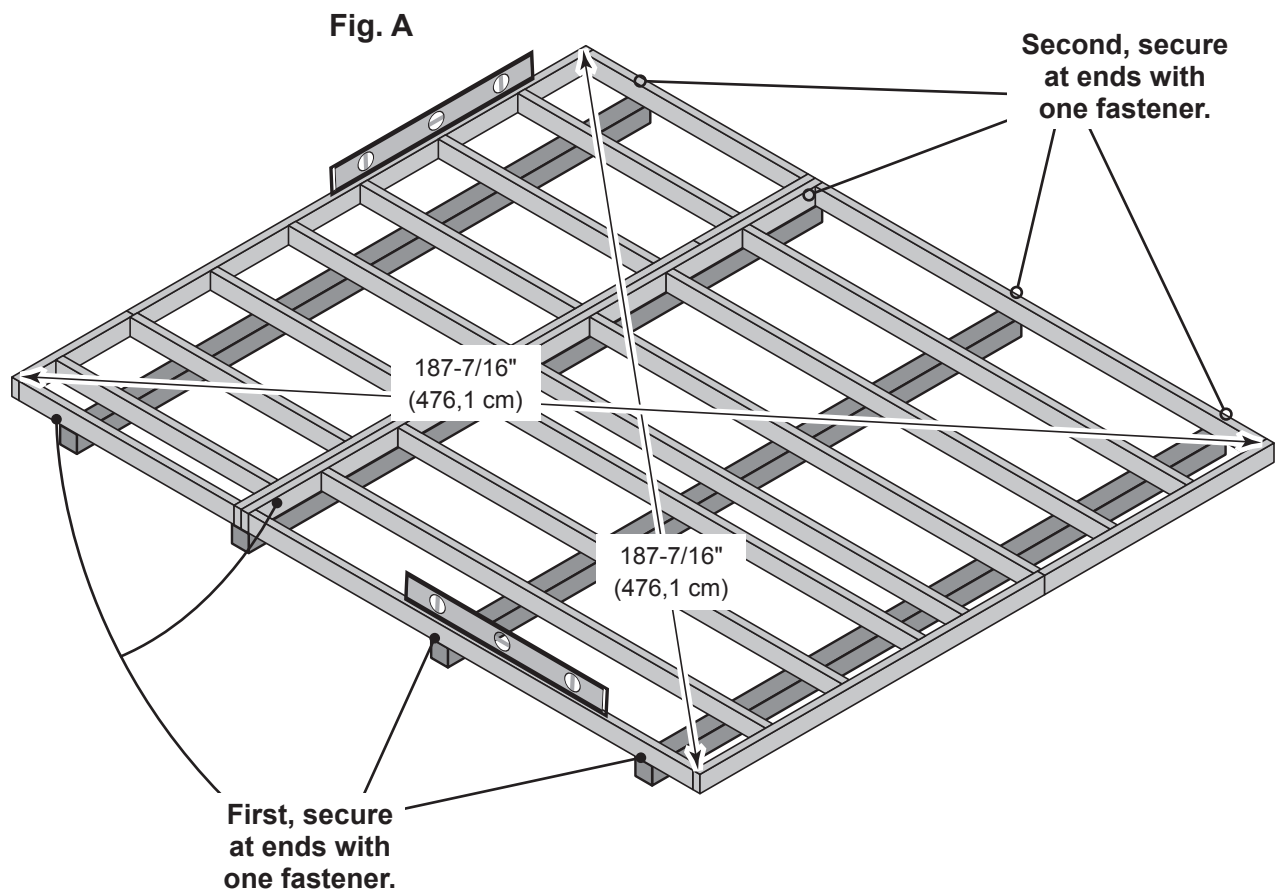

Once the floor frame is level and square fasten the frame to the 4x4 runners at each point the frame contacts the 4x4 runners.

FLOOR PANELS

PARTS REQUIRED:

x1  5/8 x 48 x 96"
(1,6 x 121,9 x 243,8 cm)

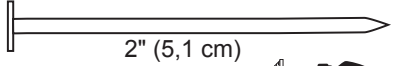
x62  2" (5,1 cm)



 **Ensure your floor frame is square by installing one panel and squaring the frame.**

✓ **BEGIN**

1 Attach the **48" x 96"** panel with the rough side up (painted-grid lines side) with the 48" edge and corner flush to the floor frame (**Fig. A**). Secure panel with (2) 2" nails in the corners.

2 Move to the opposite side.
Using the long edge of the panel as a lever,
move the panel side-to-side until the corner is flush
to the floor frame (**Fig. B**).
Secure panel with (2) 2" nails in the corners.

3 Continue attaching the panel with 2" nails spaced 6" apart on
edges and 12" apart inside panel.
Use a chalk line or use pre-painted grid lines to nail into joists
under panel.

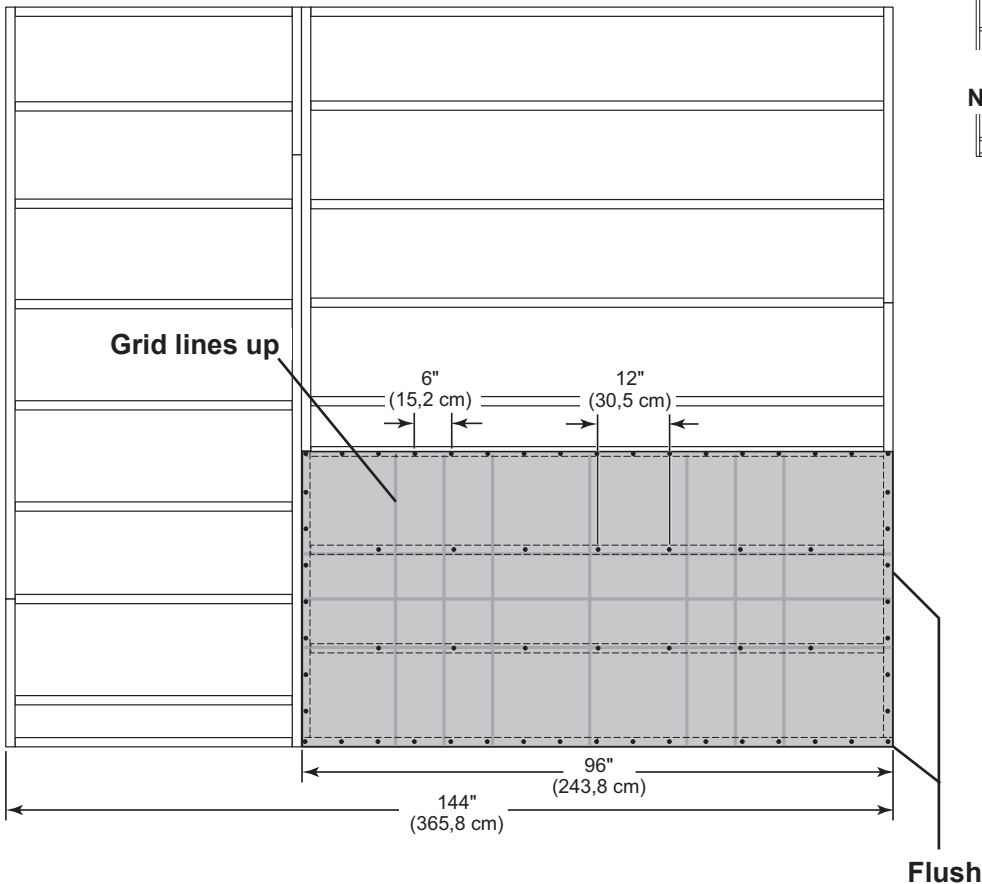
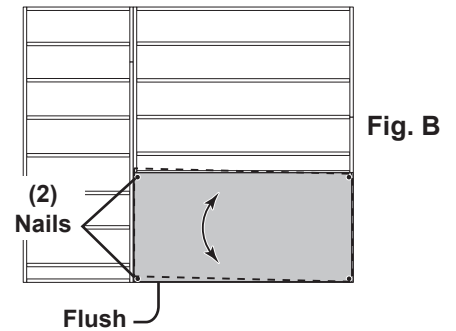
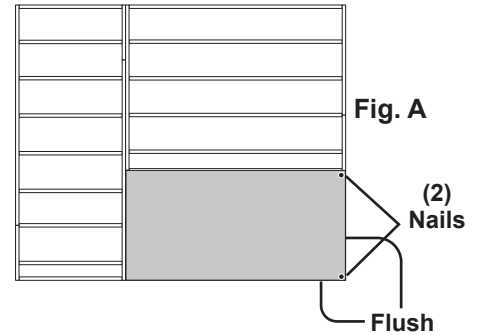

FLOOR PANELS

PARTS REQUIRED:

x2 
 5/8 x 48 x 96"
 (1,6 x 122 x 243,8 cm)

x1 
 5/8 x 23-7/8 x 48"
 (1,6 x 60,6 x 122 cm)

x1 
 5/8 x 23-7/8 x 96"
 (1,6 x 60,6 x 243,8 cm)

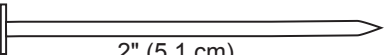
x199 
 2" (5,1 cm)

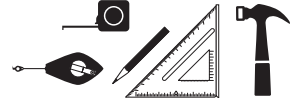

- 5 Continue installing panels with rough side up (painted grid lines).
- 6 Use grid lines on panel for 2" nails 6" apart on edges, and 12" apart inside panels.

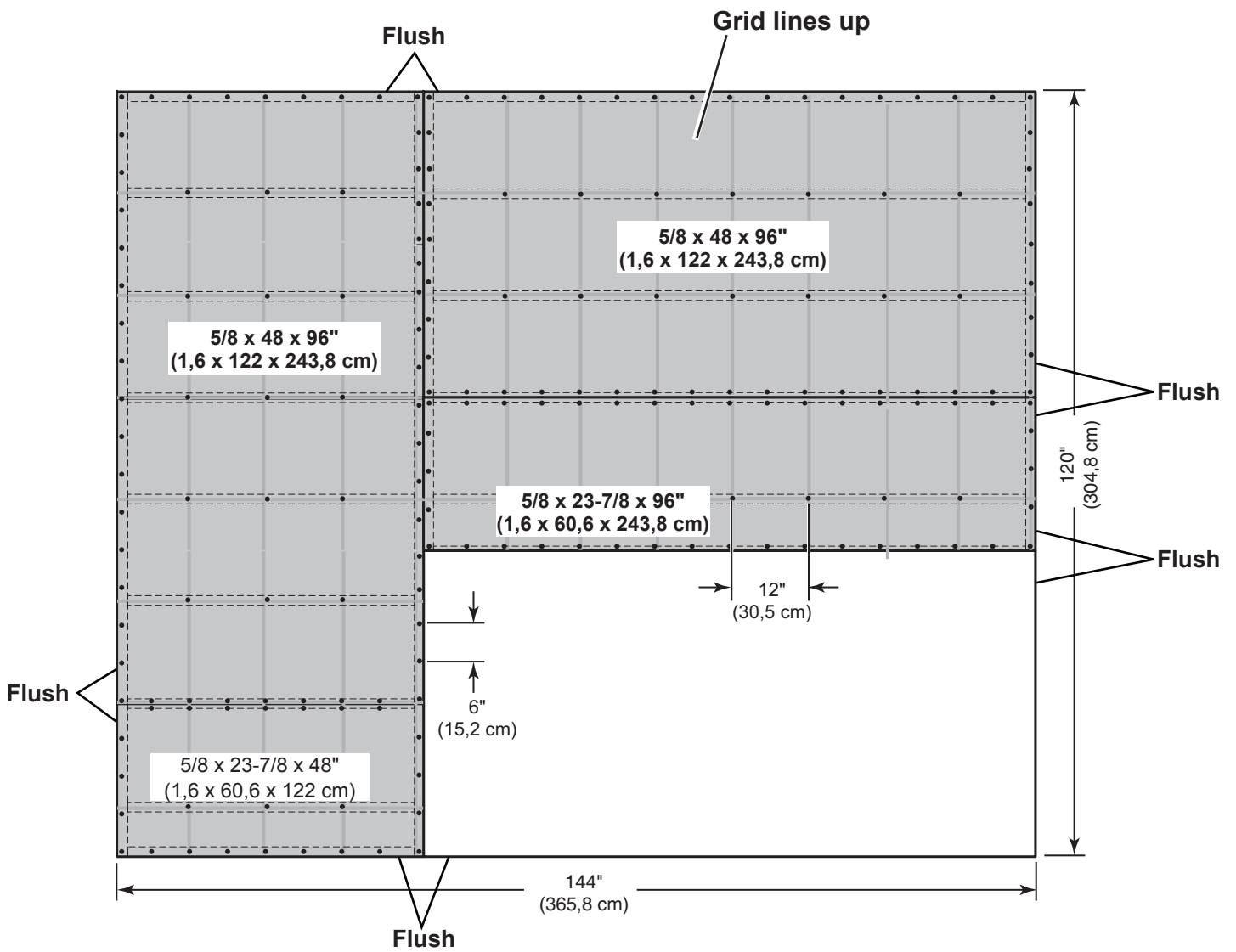

Your floor panels are now installed

IMPORTANT!

STOP!

Check the floor frame is level after installing floor panels.
Re-level if needed.

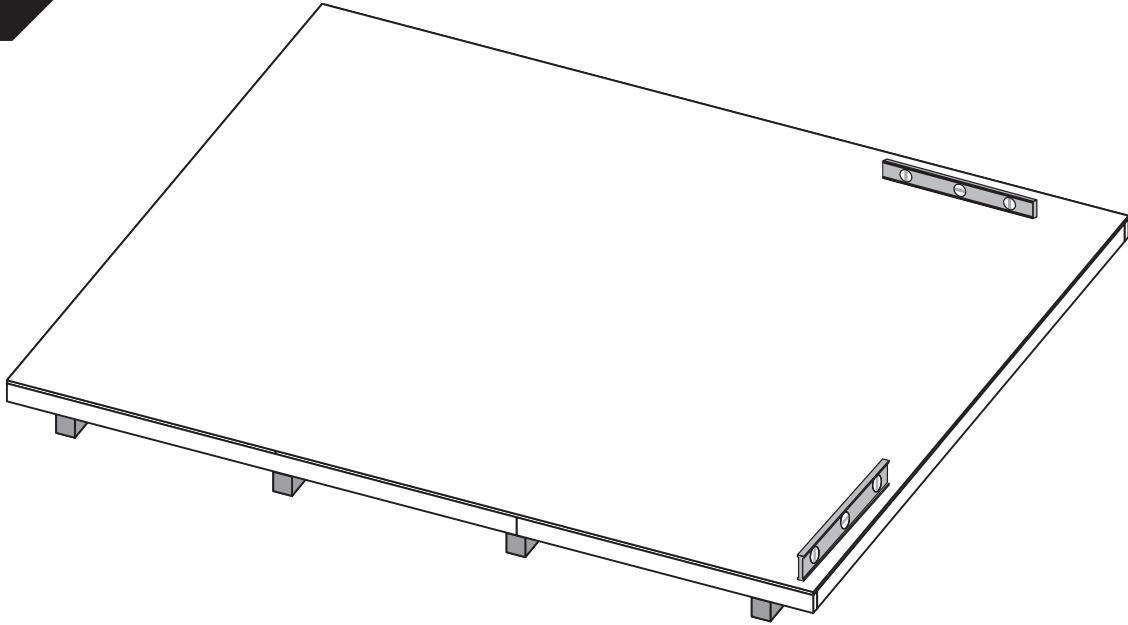

HINT:

- The floor should be used as a stable work surface for wall construction.
- Organize your assembly procedure during the build process to avoid over-handling of the walls.

BACK WALL

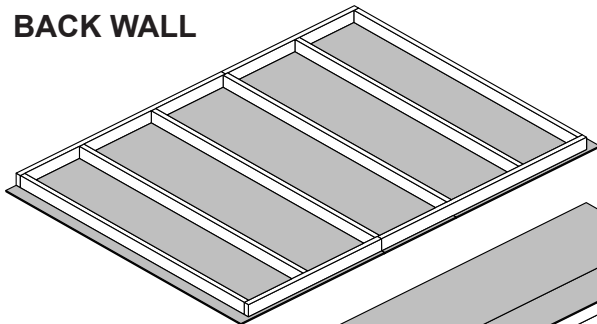

12' EAVE WALL

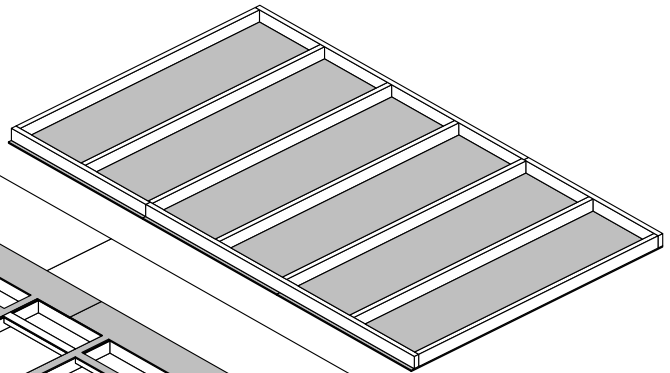

12' WINDOW WALL

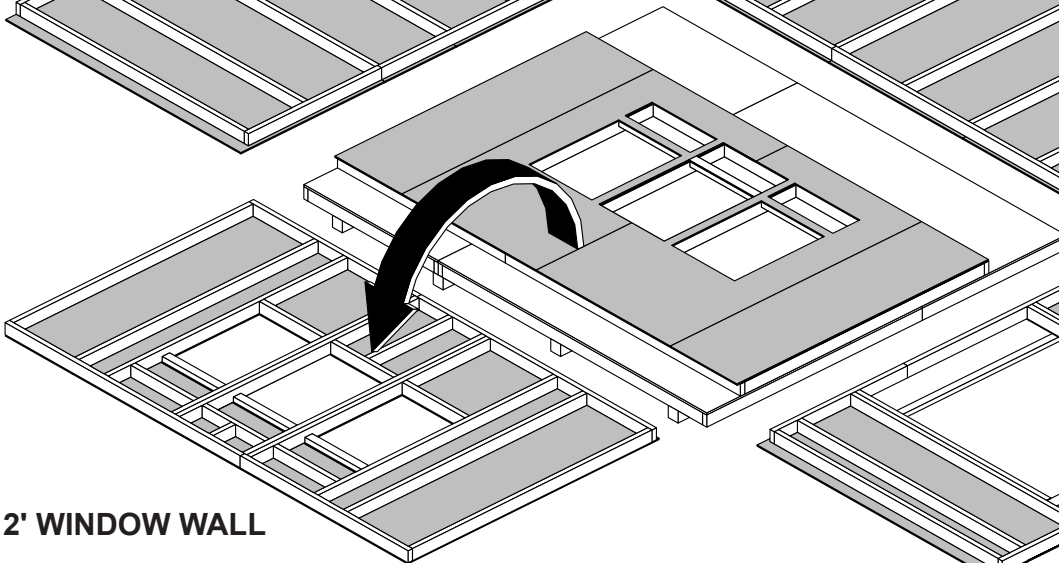

FRONT WALL

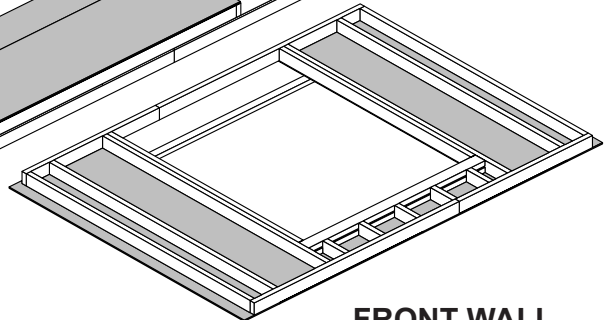

MAIN ROOF RAFTER ASSEMBLY

PARTS REQUIRED:

x2 **GPC** 2 x 4 x 4-3/8" (5,1 x 10,2 x 11,1 cm)

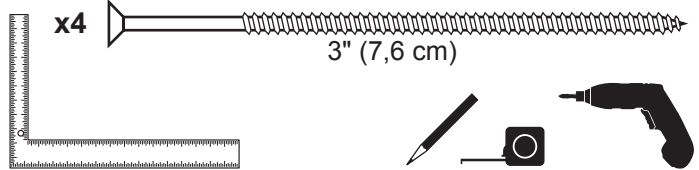

Build a rafter jig using the gable end of floor and (2) **GPC** parts as shown.

BEGIN

- Secure (1) **GPC** flush to the floor deck with (2) 3" screws.
Measure over 120-3/4" and install a second **GPC** flush to the floor deck. **GPC** will overhang the floor.
Secure with (2) 3" screws.

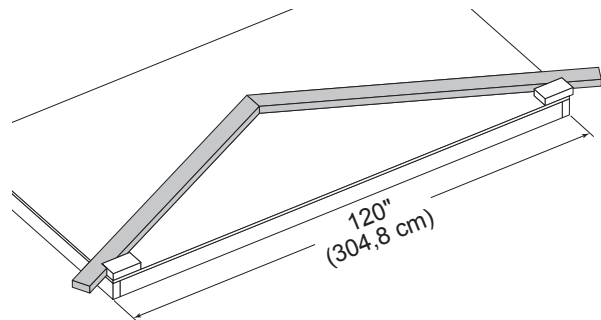
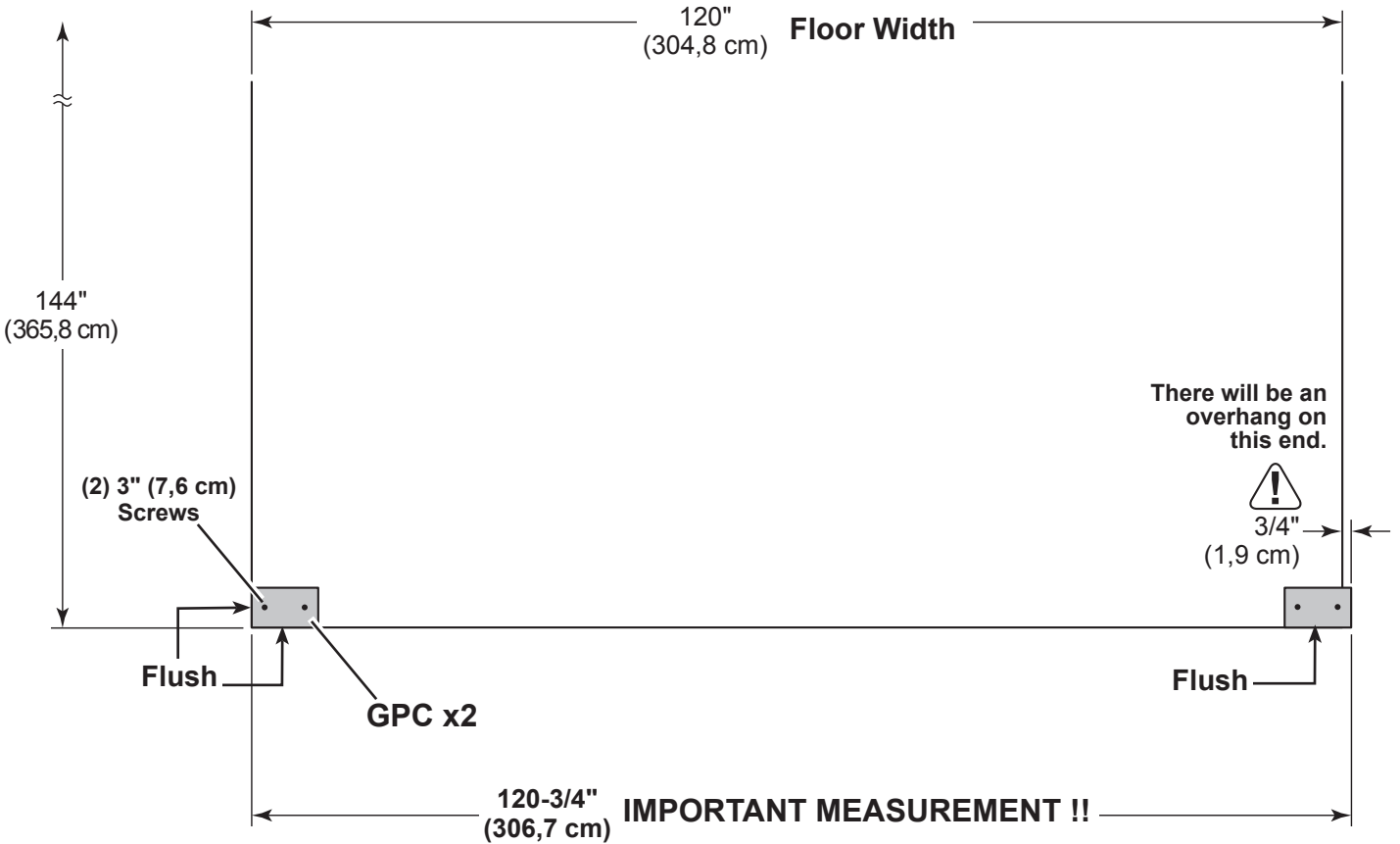

FINISH

You have finished building the main roof rafter jig. Proceed to assemble your rafters.

MAIN ROOF RAFTER ASSEMBLY

PARTS REQUIRED:

x2  OSB OR WOOD GRAIN
6 x 24" (15,2 x 61 cm) **NOTE:** 6" (15,2 cm) Gusset

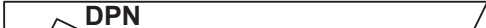
x4  DPN
2 x 4 x 73-3/4" (5,1 x 10,2 x 187,3 cm)

x24  2" (5,1 cm)



✓ BEGIN

- 1 Place (2) rafters **DPN** into the jig as shown.
- 2 Keep rafters **DPN** firm against (2) **GPC**'s as shown (**Fig.A**).
Flush rafters at the peak.

Place gusset on rafters holding a 1/4" gap from edge.
Secure gusset with (1) 2" nail into each rafter.
HINT: These first (2) nails will help hold the measurements when you nail on gussets.

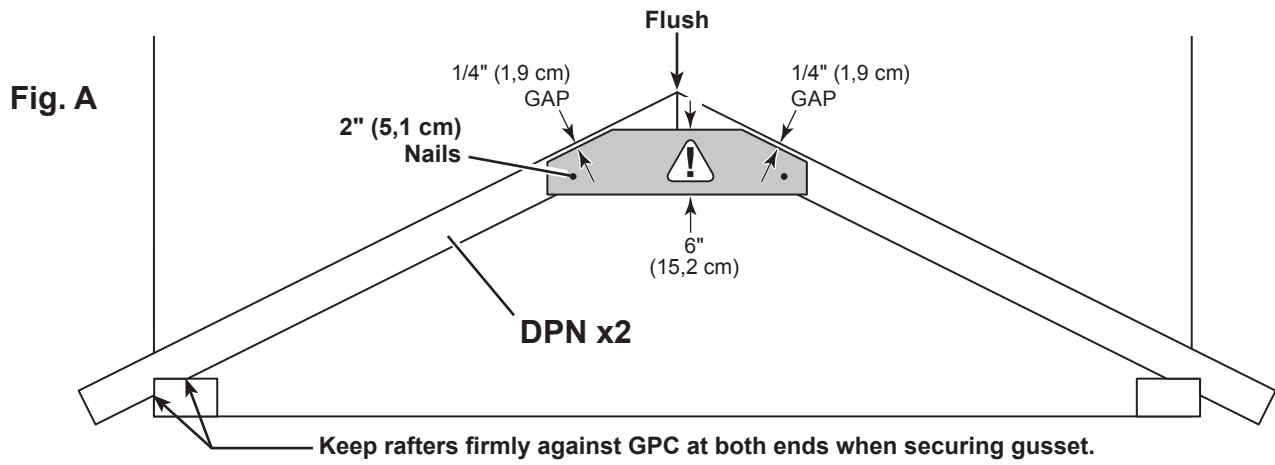

- 3 Secure gusset with (10) 2" nails in the pattern shown (**Fig. B**).

Repeat STEPS 1 and 2 to assemble (1) more single gusset rafter.

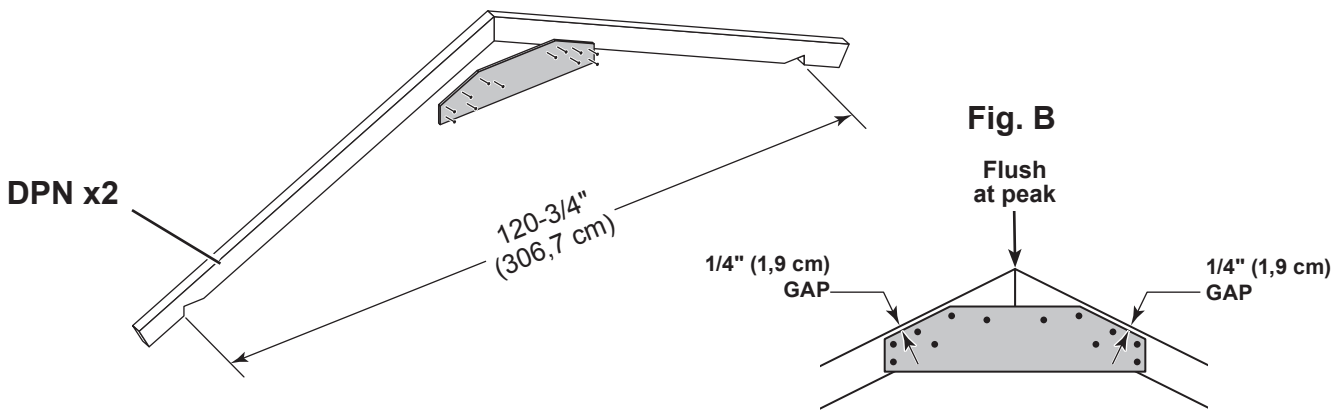

Remove **GPC** parts from floor.



Your (2) main roof rafters are now assembled..

DORMER RAFTER ASSEMBLY

PARTS REQUIRED:

x2 **GPC** 2 x 4 x 4-3/8" (5,1 x 11,1 x 14,9 cm)

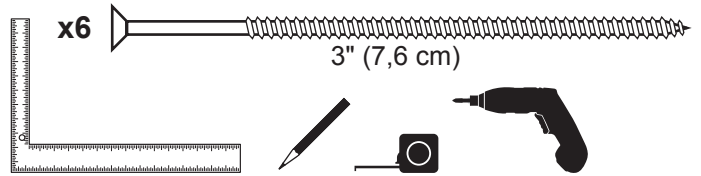

Build a rafter jig using the gable end of floor and (2) **GPC** parts as shown.

✓ BEGIN

- 1 Measure 120-3/8" (306,7 cm) from the floor edge. Install (1) **GPC** flush to the floor deck.
GPC will overhang the floor.
 Secure with (2) 3" screws.

- 2 Measure 17-11/16" (44,9 cm) from the floor edge.
 Secure (1) **GPC** flush to the floor deck with (2) 3" screws.

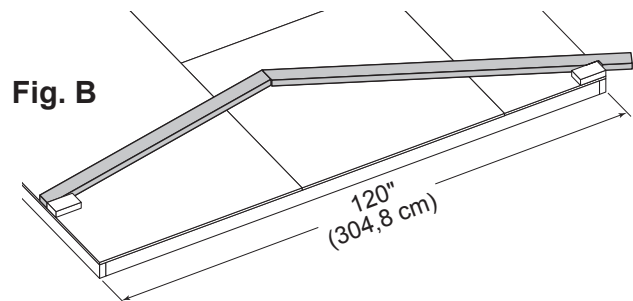
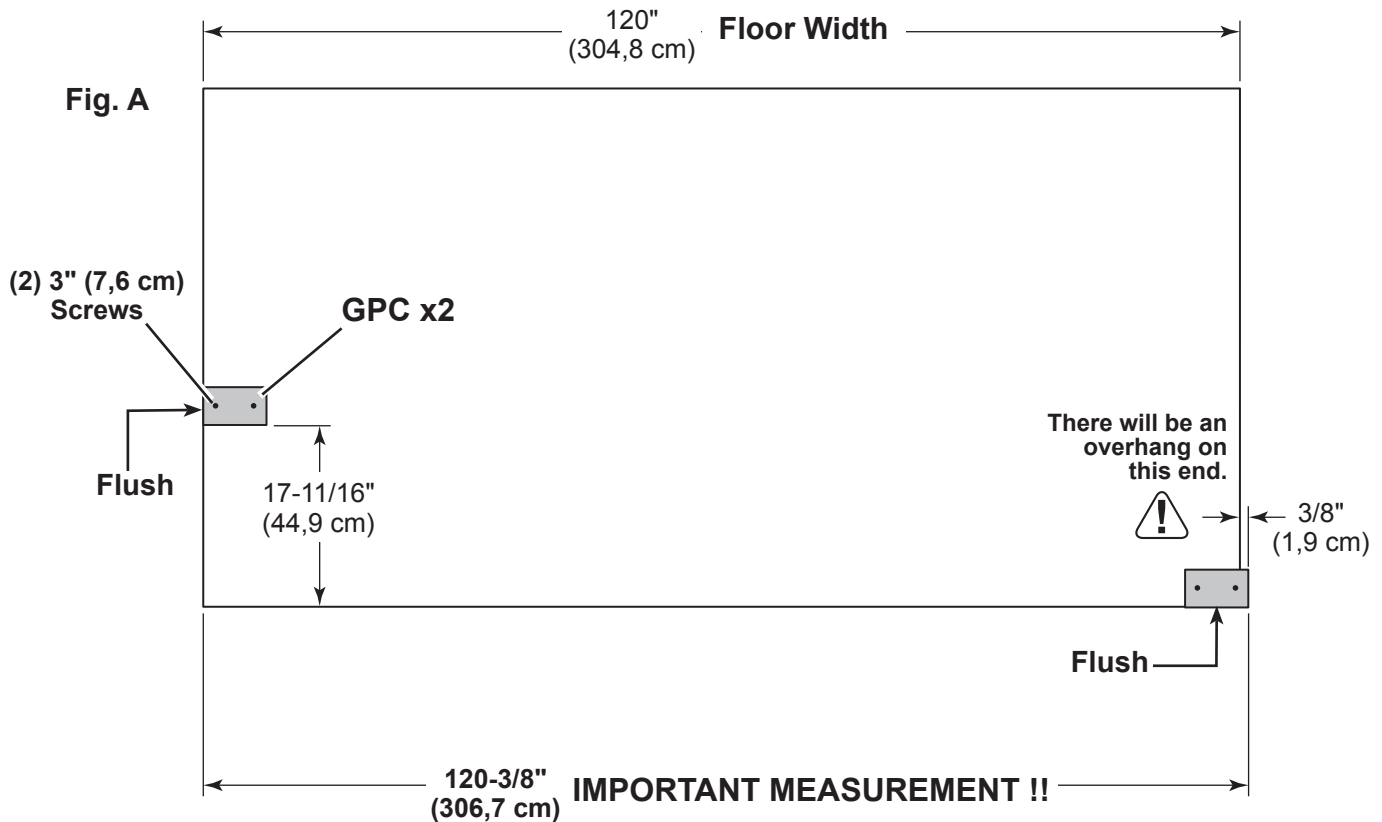

You have finished building the main roof rafter jig. Proceed to assemble your dormer rafters.

DORMER RAFTER ASSEMBLY (CENTER 3 GUSSETS)

PARTS REQUIRED:

x6  OSB OR WOOD GRAIN
4-13/16" x 24" (12,2 x 61 cm)
NOTE: 4-13/16" (15,2 cm) Gusset

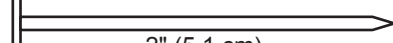
x72  2" (5,1 cm)

x3  BVT 2 x 4 x 61-1/4" (5,1 x 10,2 x 155,6 cm)

x3  DPN 2 x 4 x 73-3/4" (5,1 x 10,2 x 187,3 cm)



✓ BEGIN

- 1 Place rafters **BVT** and **DPN** into the jig as shown.
- 2 Keep rafters firm against (2) **GPC's** as shown (**Fig.A**).
Flush rafters at the peak.

Place gusset on rafters holding a 1/4" gap from edge.

Secure gusset with (1) 2" nail into each rafter.

HINT: These first (2) nails will help hold the measurements when you nail on gussets.

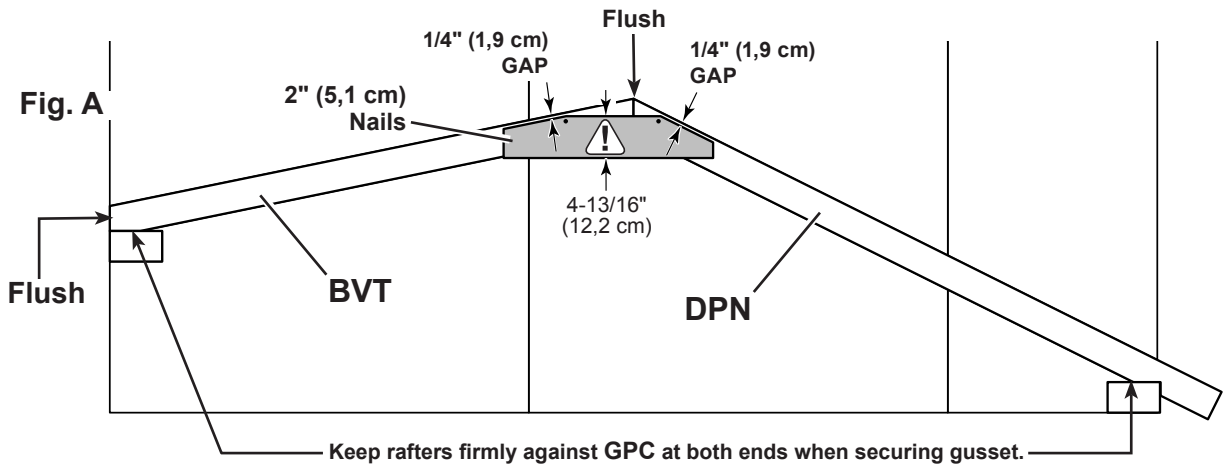

- 3 Secure gusset to the rafters with (12) 2" nails in the pattern shown (**Fig. B**).

Flip rafters over and attach a second gusset with (12) 2" nails. No need to use jig for this gusset.

Repeat STEPS 1 - 3 to assemble two more double gusset dormer rafters.

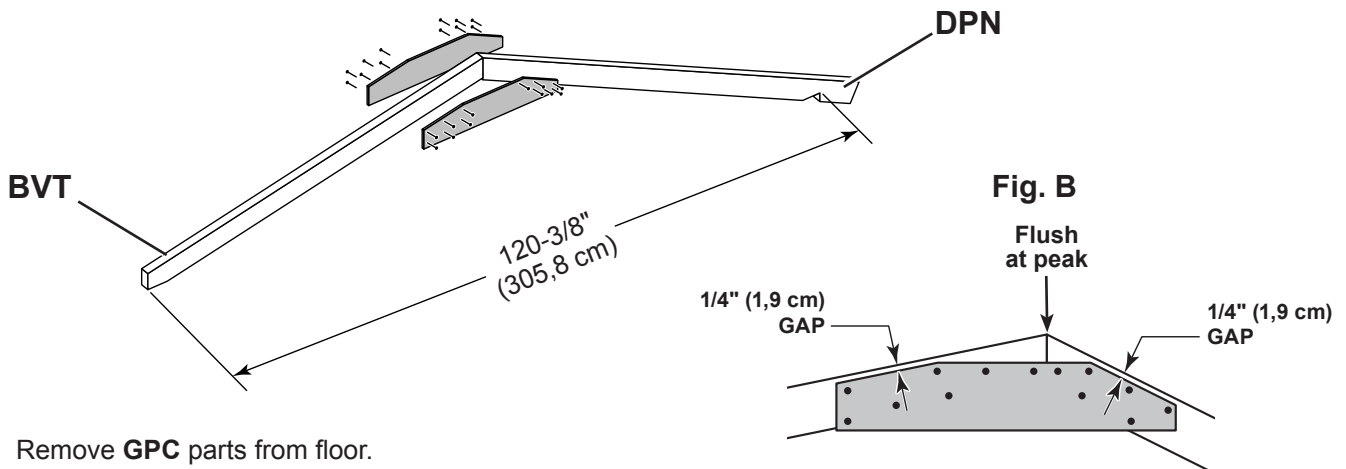

Remove **GPC** parts from floor.

DORMER RAFTER ASSEMBLY (RIGHT 1 GUSSET)

PARTS REQUIRED:

x1  OSB OR WOOD GRAIN
4-13/16" x 24" (12,2 x 61 cm)
NOTE: 4-13/16" (15,2 cm) Gusset

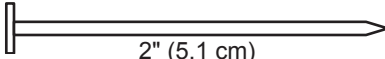
x12  2" (5,1 cm)

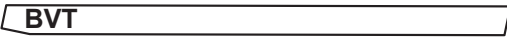
x1  **BVT** 2 x 4 x 61-1-4" (5,1 x 10,2 x 155,6 cm)

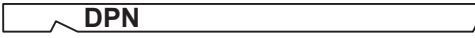
x1  **DPN** 2 x 4 x 73-3/4" (5,1 x 10,2 x 187,3 cm)



4 Place rafters **BVT** and **DPN** into the jig as shown.

5 Keep rafters firm against (2) **GPC's** as shown (**Fig.A**).
Flush rafters at the peak.

Place gusset on rafters holding a 1/4" gap from edge.

Secure gusset with (1) 2" nail in each rafter.

HINT: These first (2) nails will help hold the measurements when you nail on gussets.

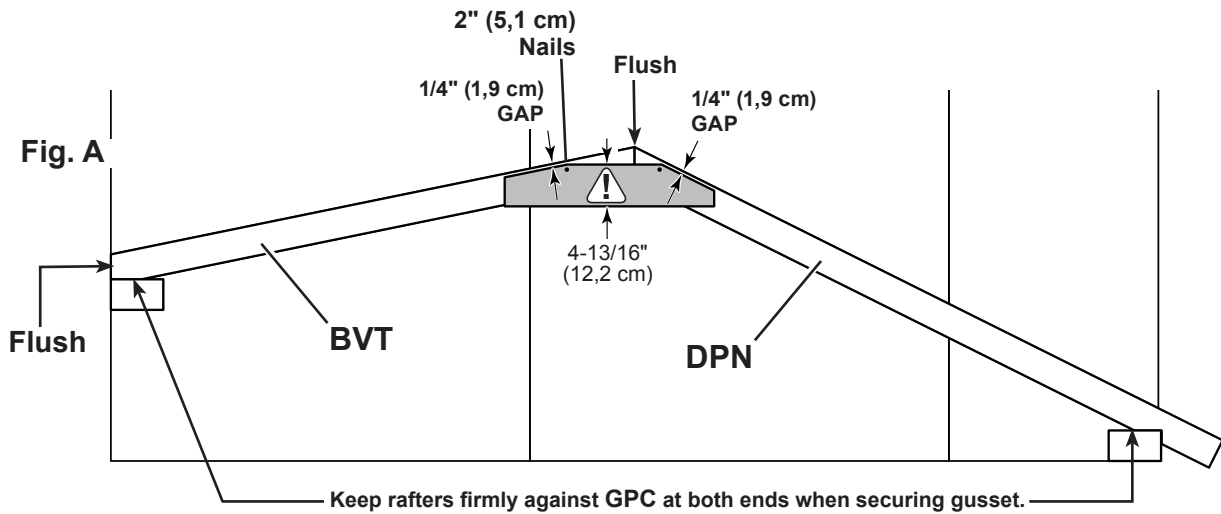

6 Secure gusset to the rafters with (12) 2" nails in the pattern shown (**Fig. B**).

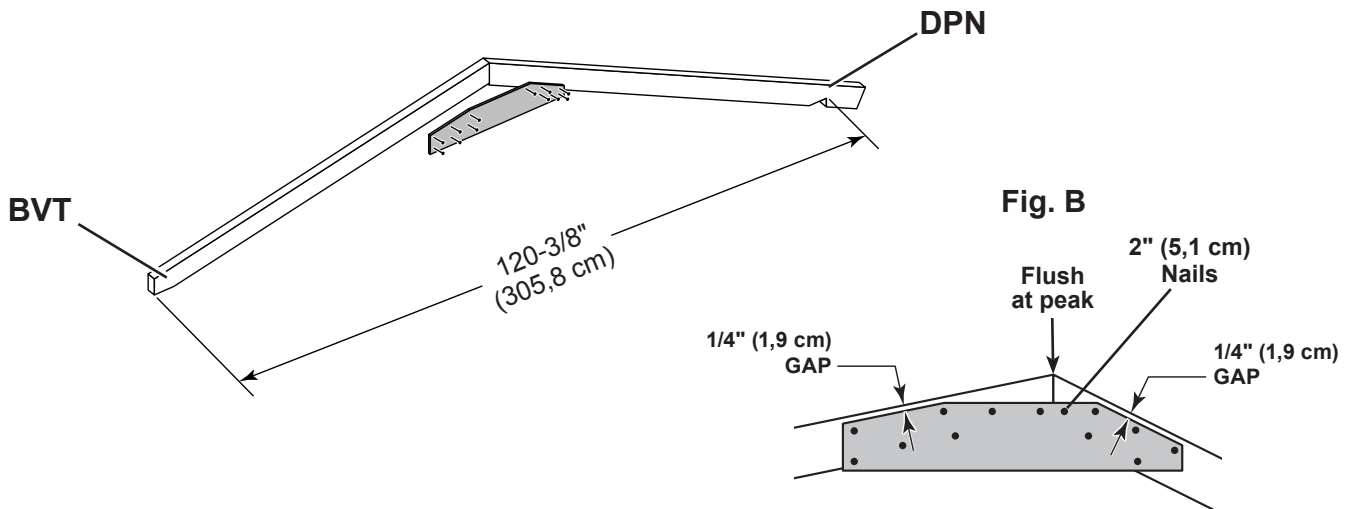

Continue to build the left dormer rafter with only (1) gusset.

DORMER RAFTER ASSEMBLY (LEFT 1 GUSSET)

PARTS REQUIRED:

- x1 **BVT**
2 x 4 x 61-1/4" (5,1 x 10,2 x 155,6 cm)
- x1 **DPN**
2 x 4 x 73-3/4" (5,1 x 10,2 x 187,3 cm)

- x1 **TEMPORARY OSB PANEL**
7/16 x 7-7/8 x 23-7/8"
(1,1 x 20 x 60,6 cm)
- x1 **OSB OR WOOD GRAIN**
4-13/16 x 24" (12,2 x 61 cm)
- NOTE:** 4-13/16" (15,2 cm) Gusset

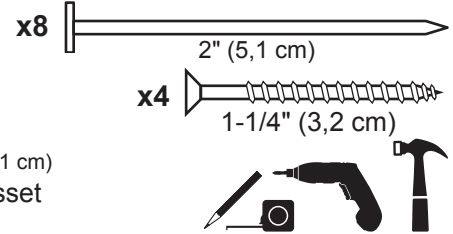

- 7** Place rafters **BVT** and **DPN** into the jig as shown.
- 8** Keep rafters firm against (2) **GPC's** as shown (**Fig.A**).
Flush rafters at the peak.

Place gusset on rafters holding a 1/4" gap from edge.
Secure temporary OSB panel with (2) 1-1/4" screws in each rafter.

HINT: The temporary OSB panel will hold the measurements when you flip over the rafters to install the gusset (**Fig B**).

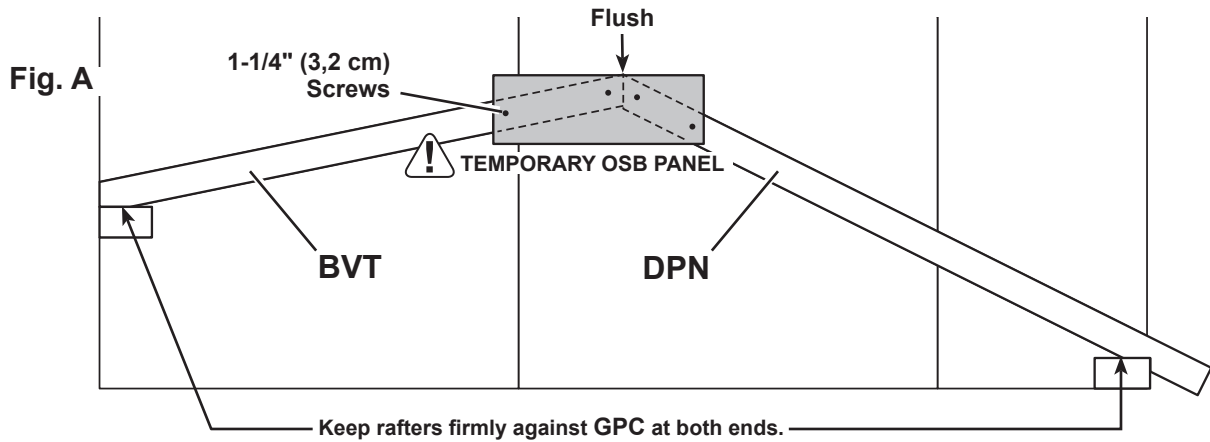

- 9** Flip rafters over and fasten the gusset with (12) 2" nails in the pattern shown (**Fig. C**).
(The jig is not necessary to install this gusset, as rafter positioning is held by the OSB.)

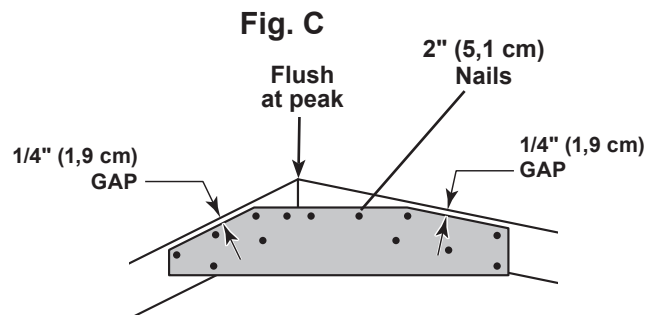
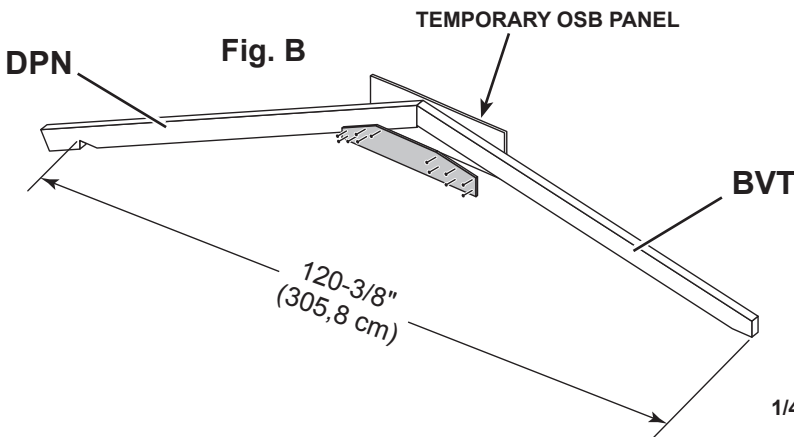

Remove temporary OSB panel from rafter and **GPC** parts from floor.



Your dormer rafters are now assembled.

DOOR HEADER

PARTS REQUIRED:

x1 
7/16 x 3-1/4 x 58-3/4" (1,1 x 8,3 x 149,2 cm)

x2 **KMA** 
2 x 4 x 59" (5,1 x 10,3 x 149,9 cm)

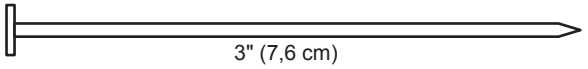
x12 
3" (7,6 cm)

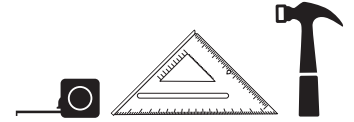

✓ **BEGIN**

- 1 Center the **3-1/4" x 58-3/4"** OSB filler between (2) parts **SX** (Fig. A, Fig. B).
Ensure ends of **KMA** are flush (Fig. A).
- 2 Nail together with 3" nails in a staggered pattern as shown.

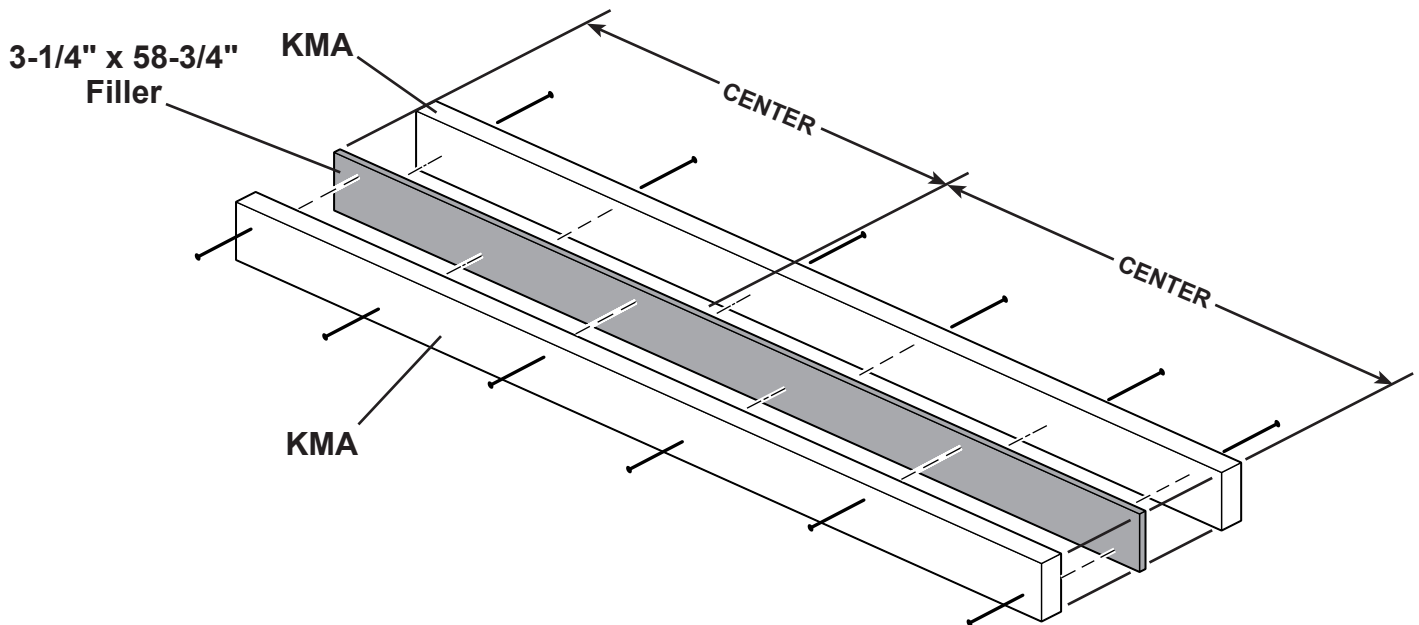
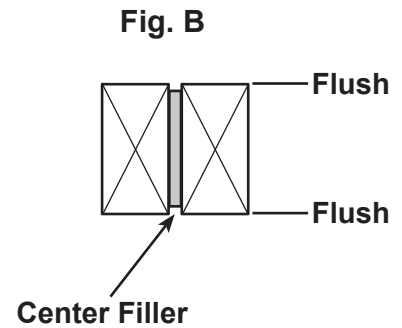
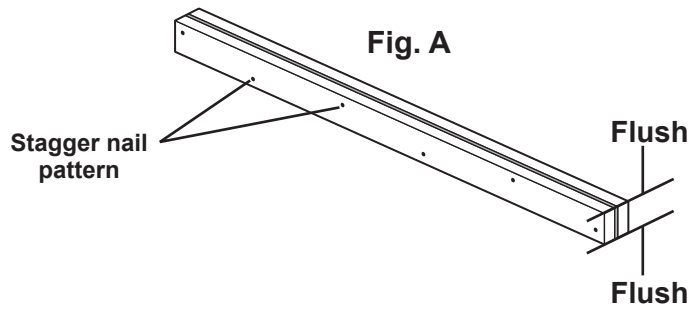

Your door header is now assembled.

GABLE OR EAVE WALL WINDOW FRAMES

PARTS REQUIRED:

x6 **AO** 2 x 4 x 22-1/2" (5,1 x 10,2 x 57,1 cm)

x3 **LV** 2 x 3 x 22-1/2" (5,1 x 7,6 x 57,1 cm)

x6 **TK** 2 x 4 x 80" (5,1 x 10,2 x 203,2 cm)

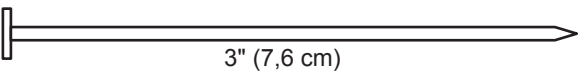
x36  3" (7,6 cm)

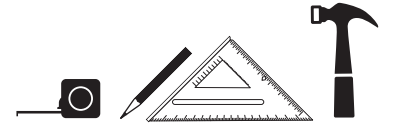

✓ BEGIN

- 1 Orient 2x4 parts on edge on floor. Lay LV on the flat side (**Fig. A**). Measure to edges of **AO** and **LV** and mark locations.



HINT:
For easier nailing
stand on frame.

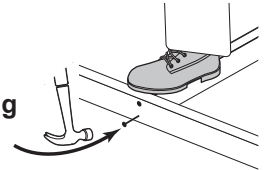

Secure parts **AO** and **LV** to **TK** with (2) 3" nails at each mark.

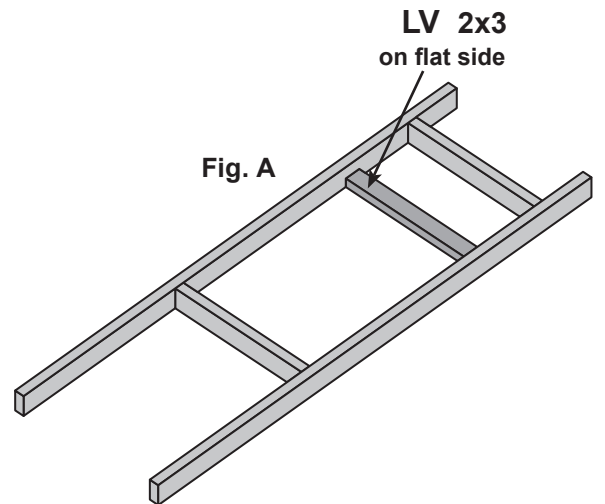
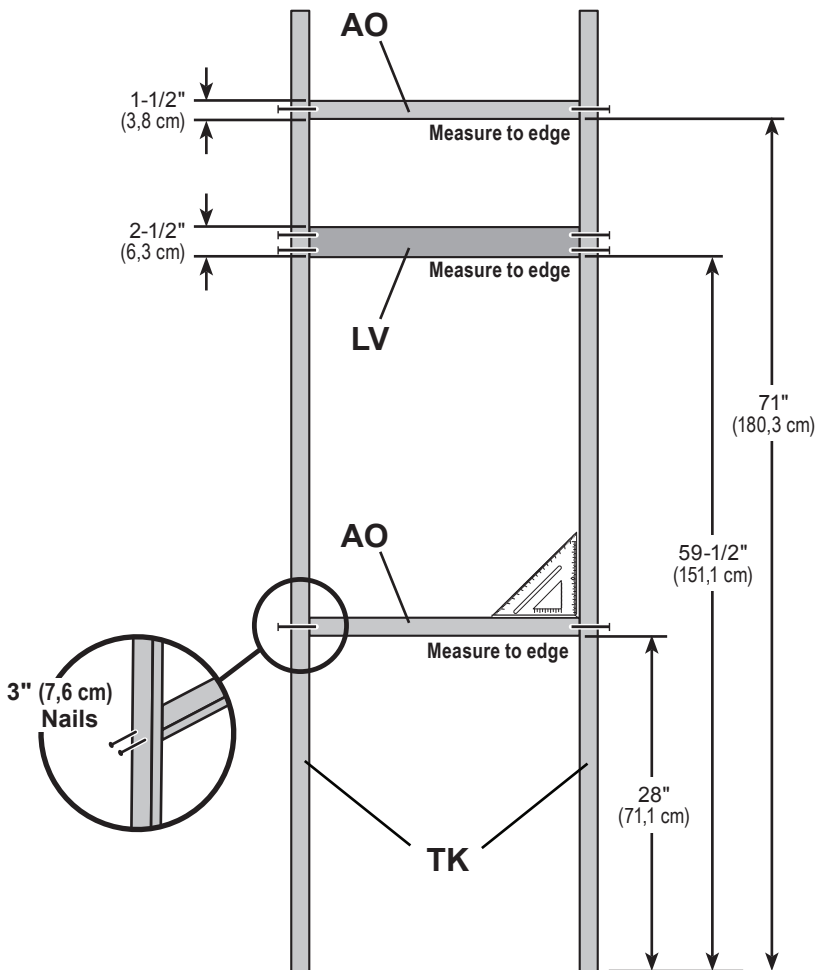

Build (2) more window frames by repeating STEP 1.



Your window frames are now assembled.

! STOP !

**CHOOSE YOUR DOOR LOCATION AT THIS TIME
AS YOU WILL ASSEMBLE YOUR DOOR WALL FIRST.**

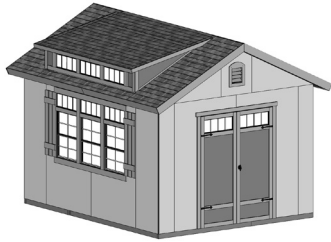

GABLE END WALL WITH DOOR:



**IF YOU CHOOSE THE GABLE END WALL FOR DOOR LOCATION
GO TO Next Page TO BEGIN BUILDING YOUR WALLS.**

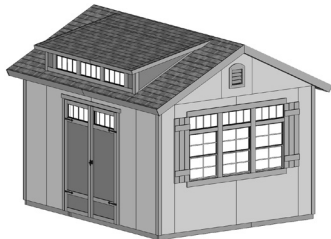

OPTIONAL:
DOOR LOCATED
ON EAVE SIDE WALL

EAVE SIDE WALL WITH DOOR:



**IF YOU CHOOSE TO LOCATE THE DOOR ON THE EAVE SIDE
GO TO Page 37 TO BEGIN BUILDING YOUR WALLS.**

10' GABLE WALL DOOR FRAME

PARTS REQUIRED:

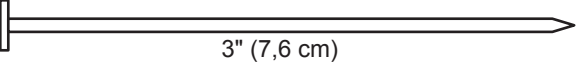
x24  3" (7,6 cm)

x4 **STL**
2 x 4 x 44-1/2" (5,1 x 10,2 x 113 cm)

x6 **TK**
2 x 4 x 80" (5,1 x 10,2 x 203,2 cm)

x6 **YFA**
2 x 4 x 68-1/2" (5,1 x 10,2 x 174 cm)



✓ BEGIN

1 Orient parts on edge on floor. Measure and mark.

Secure parts with (2) 3" nails at each mark.

HINT:
For easier nailing
stand on frame.

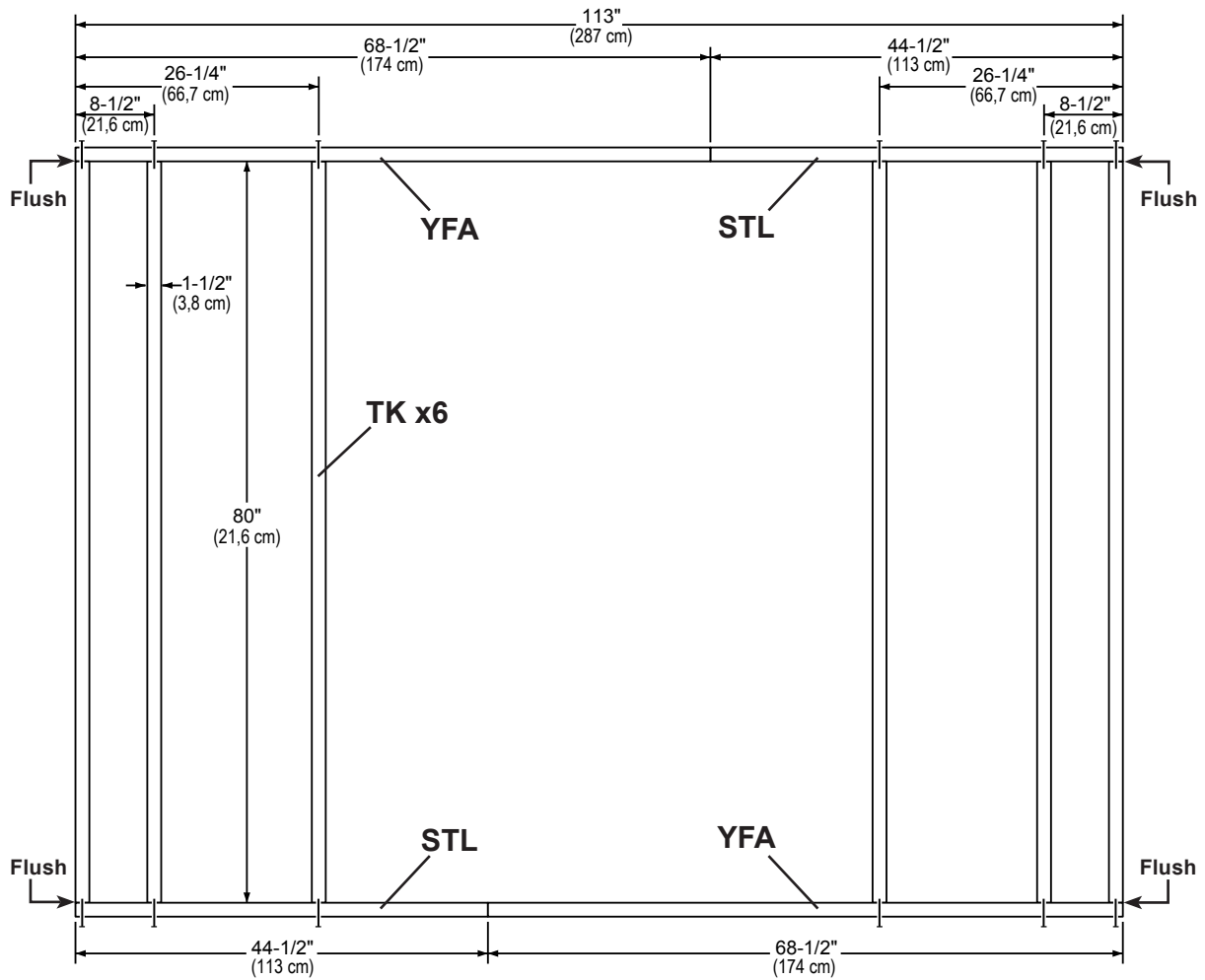
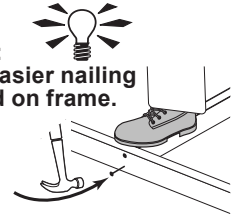

10' GABLE WALL DOOR FRAME

PARTS REQUIRED:

- x5 **COA**
2 x 4 x 8"
(5,1 x 10,2 x 20,3 cm)
- x1 **Header Assembly**
2 x 4 x 59" (5,1 x 10,2 x 149,9 cm)

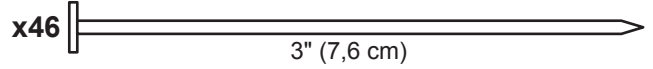

- x2 **YFA**
2 x 4 x 68-1/2" (5,1 x 10,2 x 174 cm)



2 Orient parts on edge on floor. Measure and mark.

Secure parts with (2) 3" nails at each mark and (4) 3" nails at top plate seam.

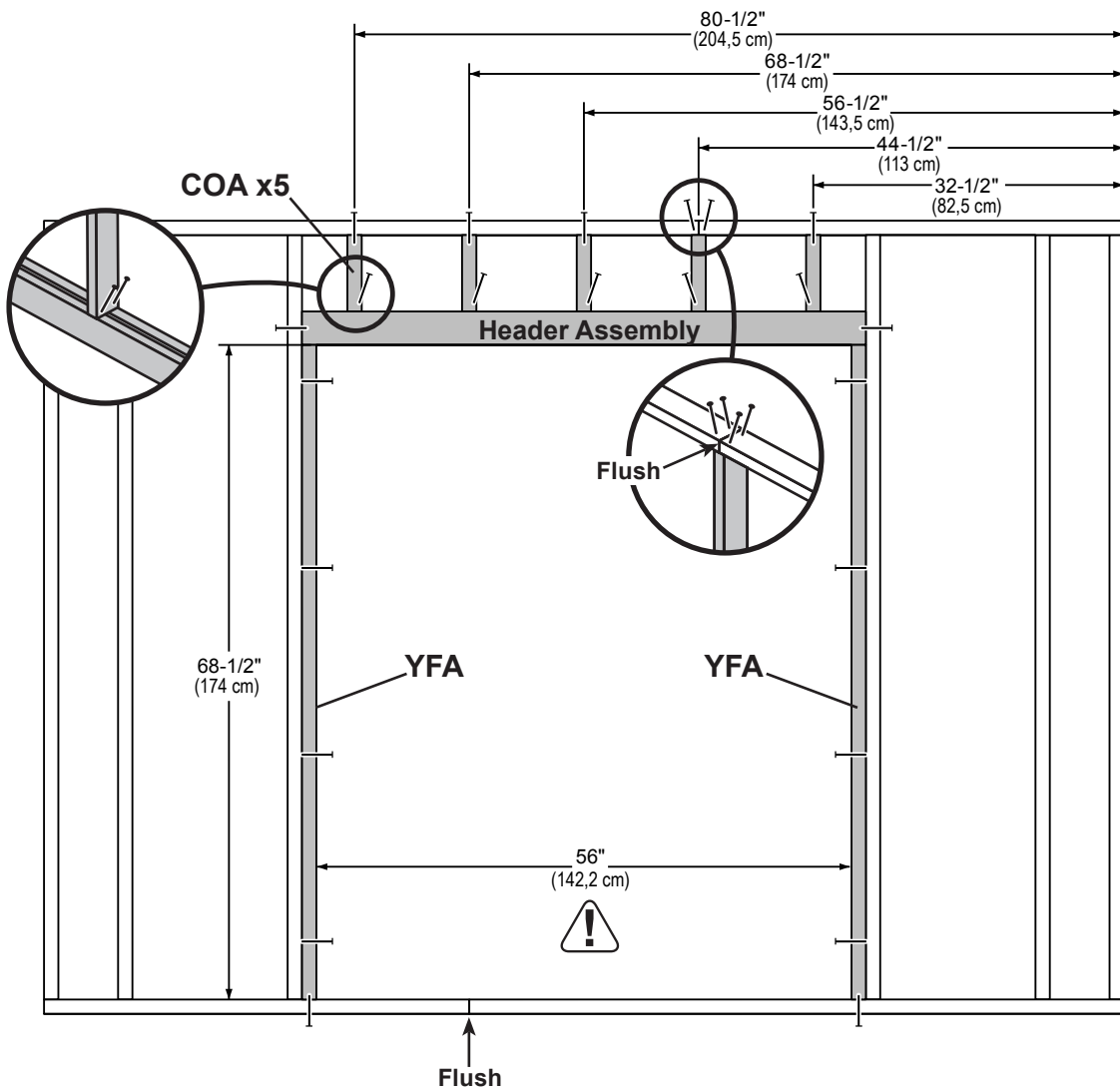

10' GABLE WALL DOOR PANELS

PARTS REQUIRED:

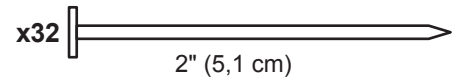
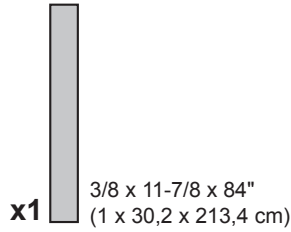

Install all panels with the primed side facing up.

✓ **BEGIN**

- 1 Place **11-7/8 x 84"** panel on wall frame flush to top of frame as shown. Use the gauge block to mark the **3/4"** measurement on the wall stud. Secure panel with 2" nails spaced 6" apart along edges.

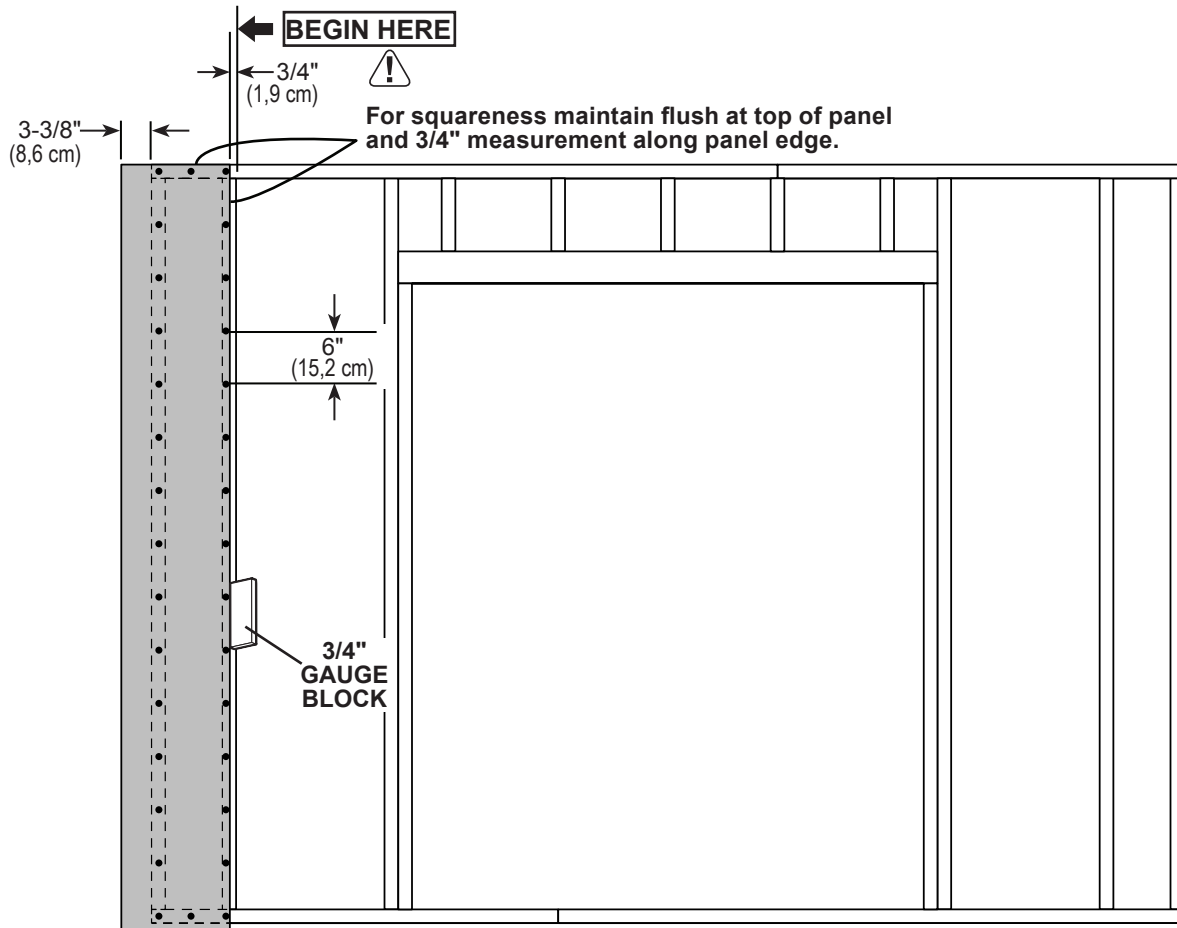

10' GABLE WALL DOOR PANELS

PARTS REQUIRED:

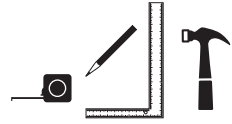
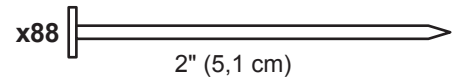
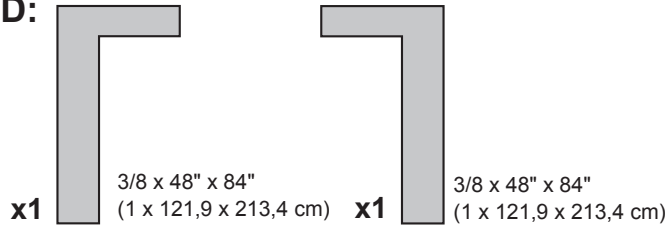

- Place left and right 48" x 84" panels on wall frame flush to top of frame. Ensure the left 48" x 84" panel is flush along edge of installed panel and both panels are flush to the top plate as shown.

Use the gauge block to ensure the 3/4" measurement on the wall stud. Secure panels with 2" nails spaced 6" apart along edges.

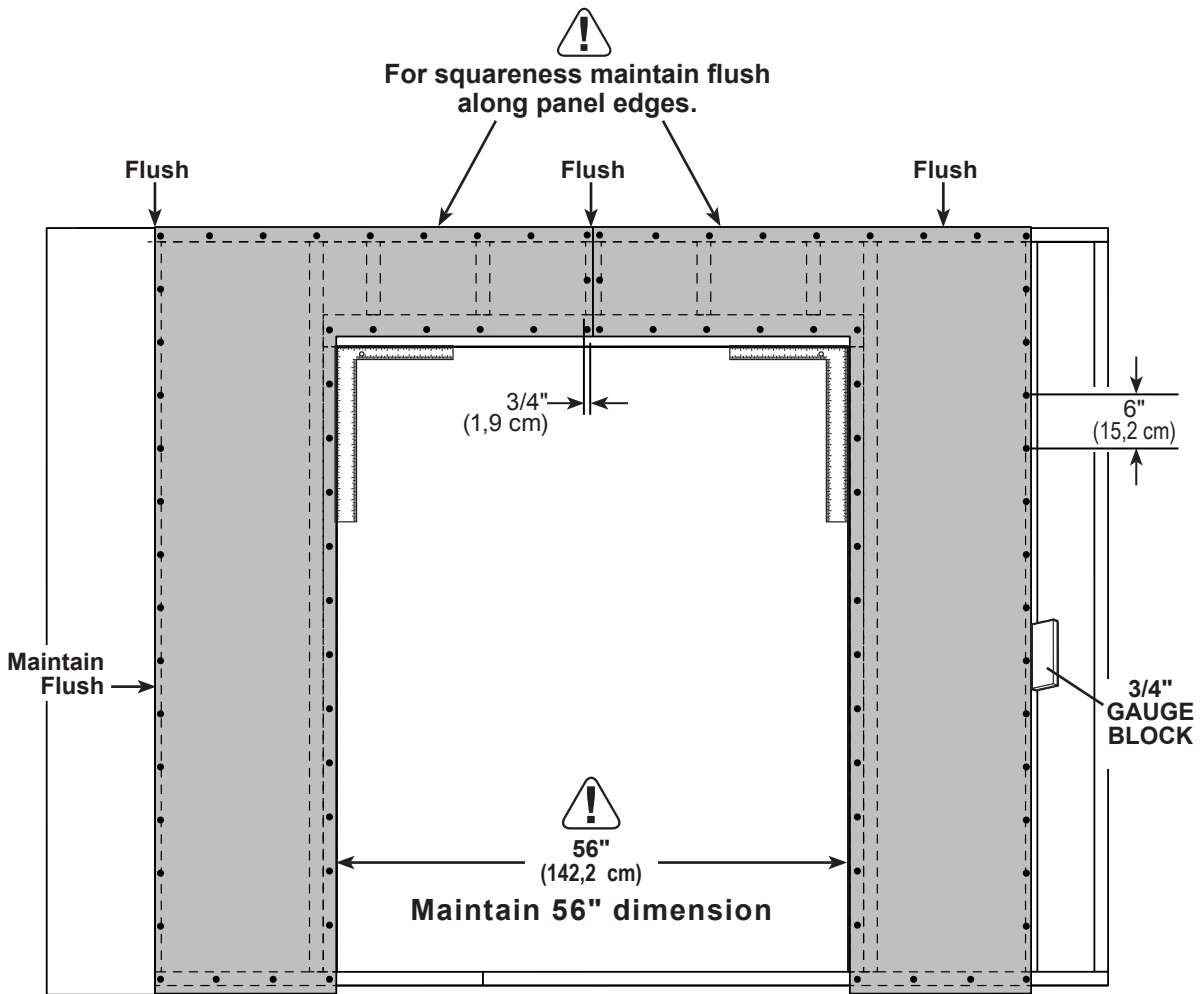

10' GABLE WALL DOOR PANELS

PARTS REQUIRED:

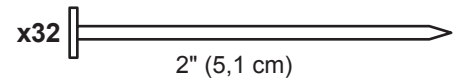
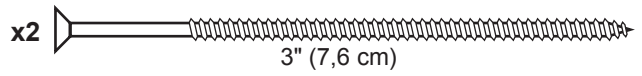
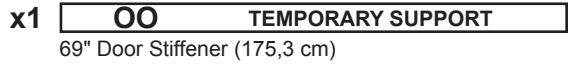
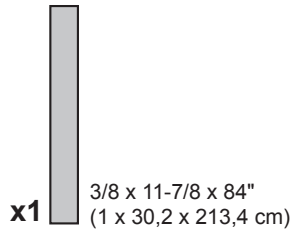

- 3** Place $11-7/8 \times 84"$ panel on wall frame flush to top of frame as shown. Secure panel with 2" nails spaced 6" apart along edges.
- 4** Install **OO** as a temporary support brace to hold the 56" (142,2 cm) measurement. Fasten **OO** with two 3" screws into studs as shown.

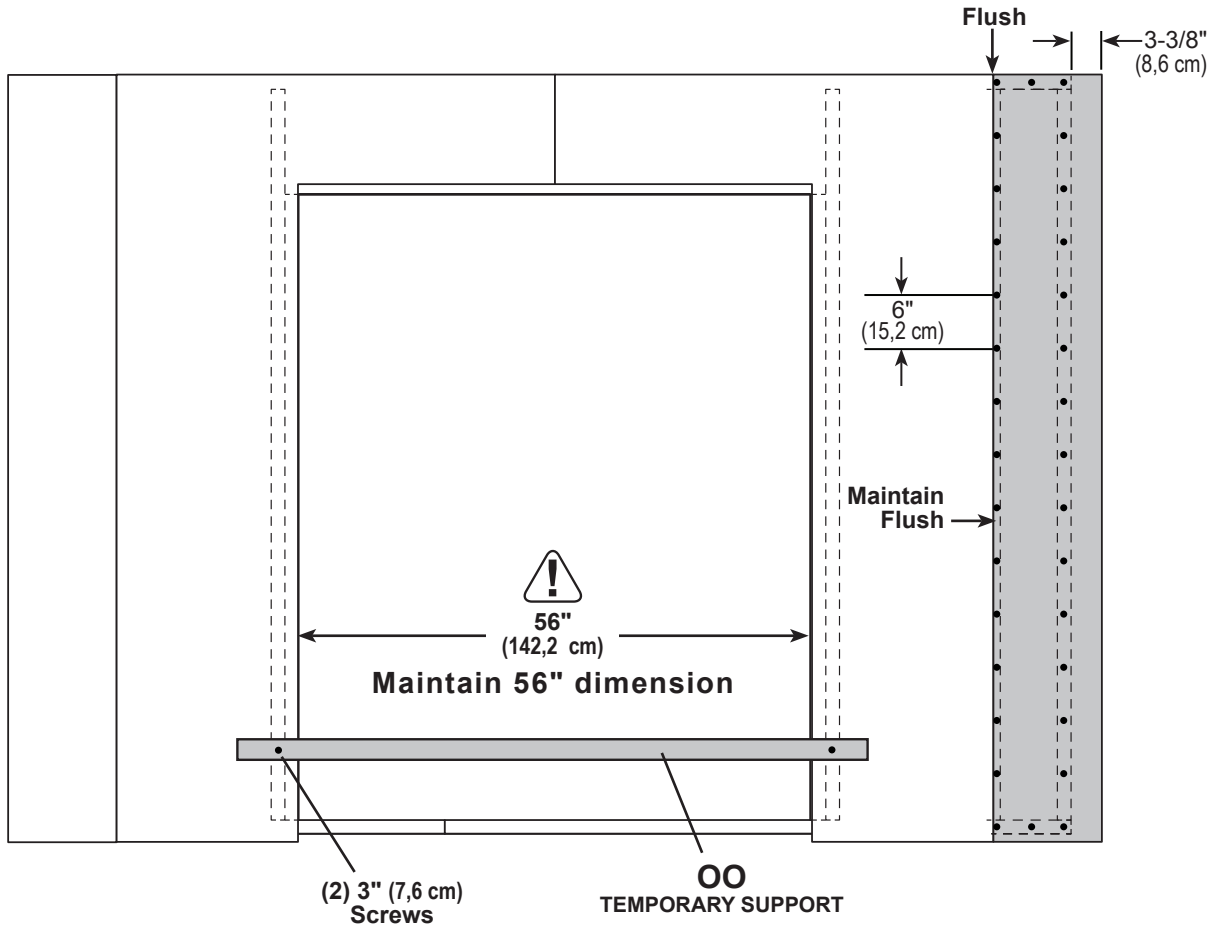

Carefully flip the 10' gable wall over.

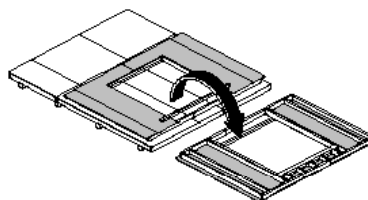

Your gable wall with door is now finished.

12' EAVE WALL WINDOW FRAME

PARTS REQUIRED:

x2 **SX**
2 x 4 x 60" (5,1 x 10,3 x 152,4 cm)

x4 **TK**
2 x 4 x 80" (5,1 x 10,2 x 203,2 cm)

x2 **TO**
2 x 4 x 84" (5,1 x 10,2 x 213,4 cm)

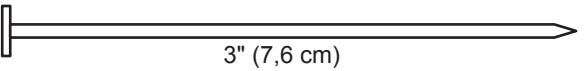
x28  3" (7,6 cm)

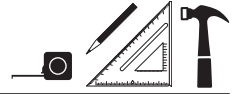
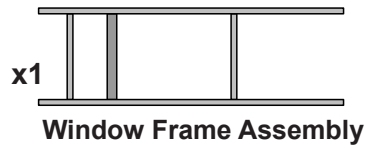

✓ BEGIN

1 Orient parts on edge on floor. Measure and mark.

Position the window frame assembly so **LV** is elevated above the floor (**Fig. A**).

Secure parts with (2) 3" nails at each mark and (4) nails at seams

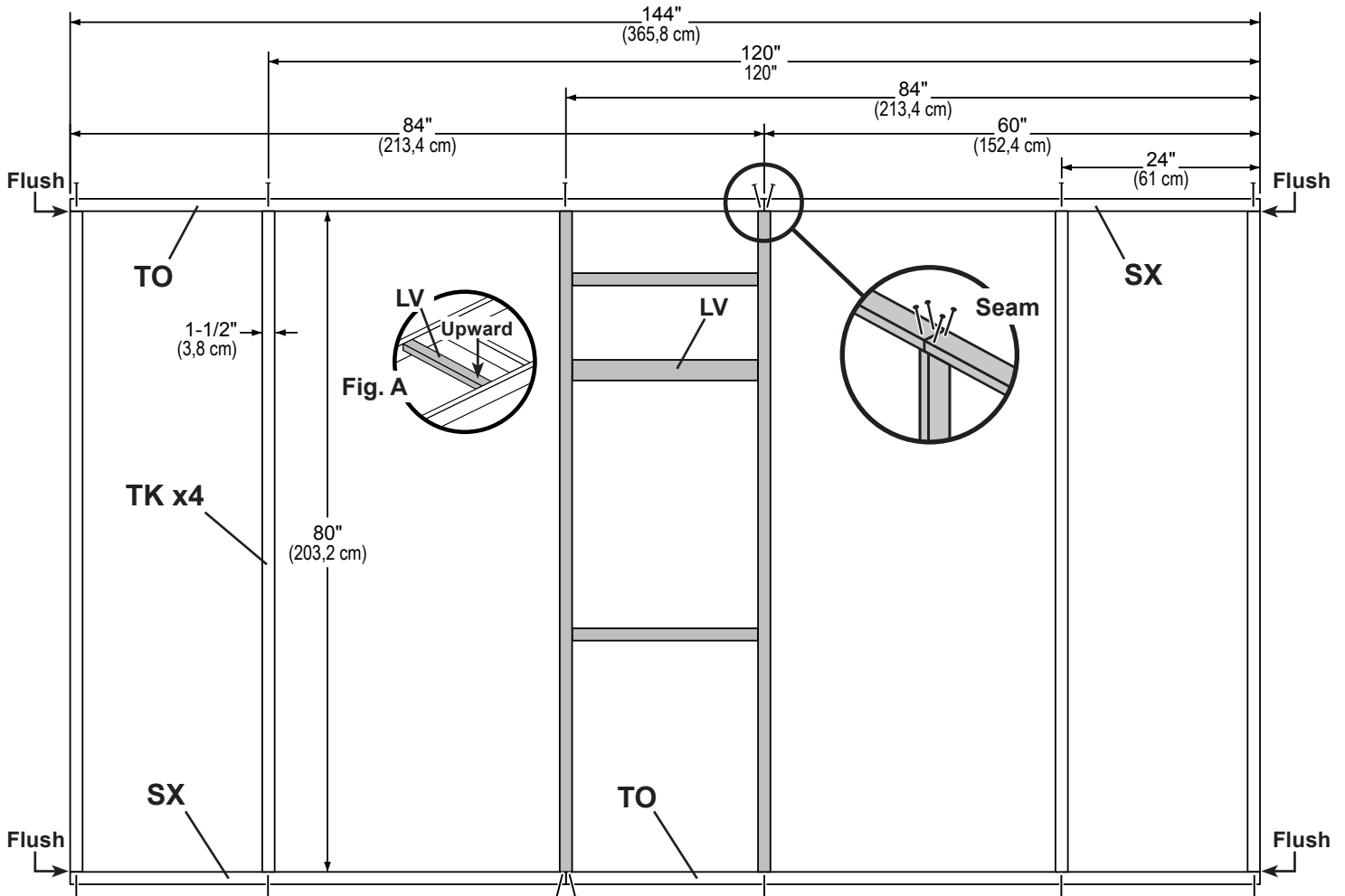
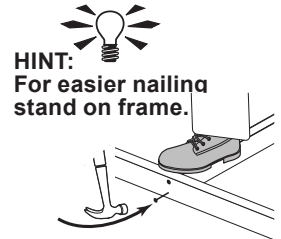

12' EAVE WALL WINDOW FRAME

PARTS REQUIRED:

x1 **AMA**
2 x 4 x 7-1/2" (5,1 x 10,2 x 35,6 cm)

x1 **RR**
2 x 4 x 28" (5,1 x 10,2 x 71,1 cm)

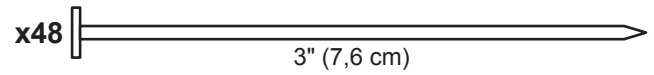
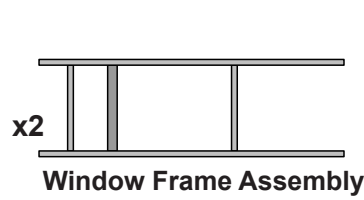

- 2 Position the (2) window frame assemblies flush to the installed window frame. Ensure that part **LV** is elevated above the floor (**Fig. A**). Center parts **AMA** and **RR** in the middle window frame assembly. Measure and mark. Secure parts with (2) 3" nails at each at each connection and as shown.

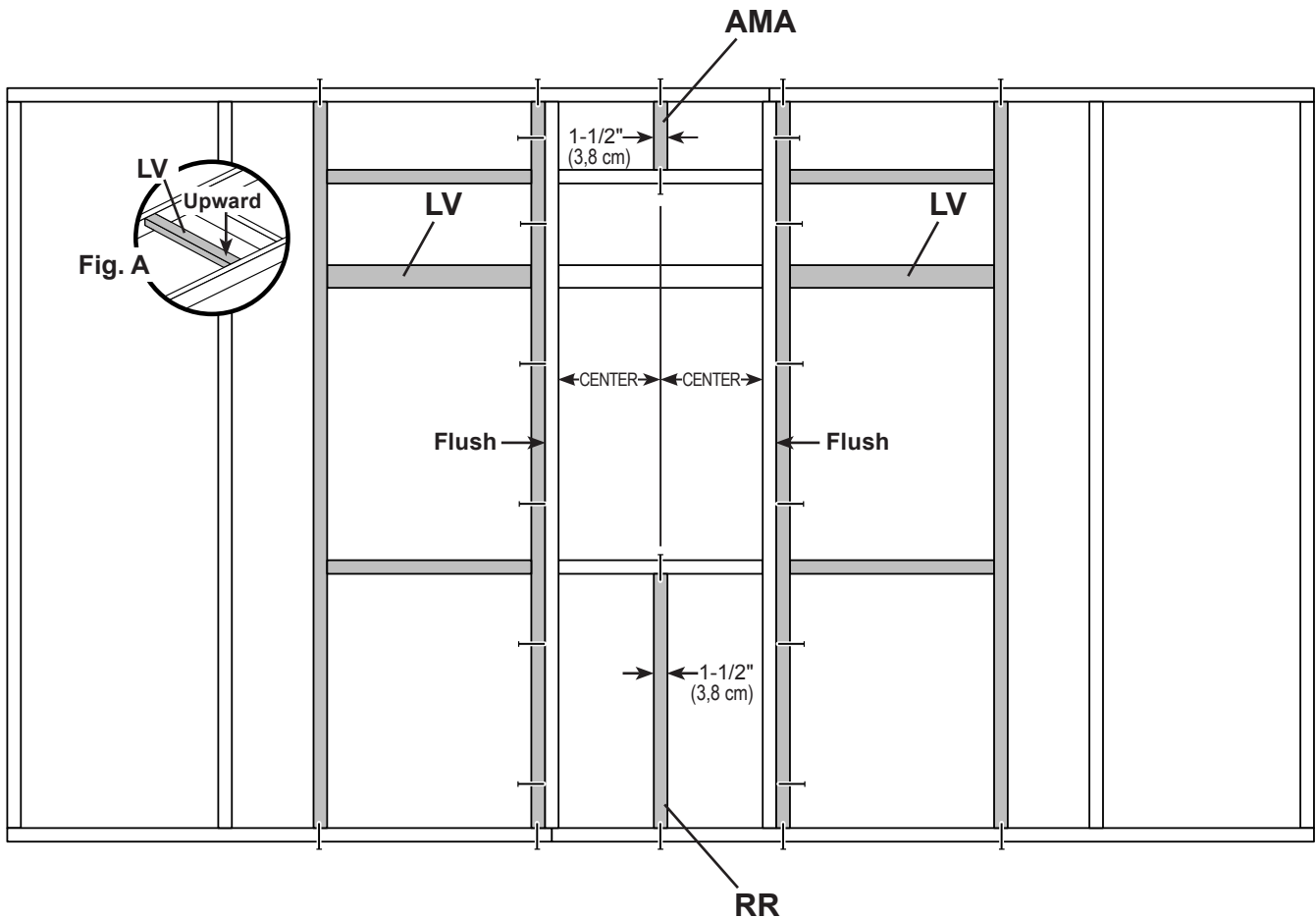

12' EAVE WALL WINDOW PANELS

PARTS REQUIRED:

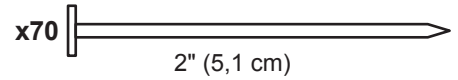
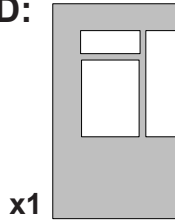

Install all panels with the primed side facing up.

✓ BEGIN

- 1 Place left 48" x 84" panel on wall frame flush to top of frame.
 Ensure panel maintains flush along edge and flush to top of frame.
 Use the gauge block to ensure the 3/4" measurement on the wall stud.
 Secure panel with 2" nails spaced 6" apart along edges and 12" apart inside panel.

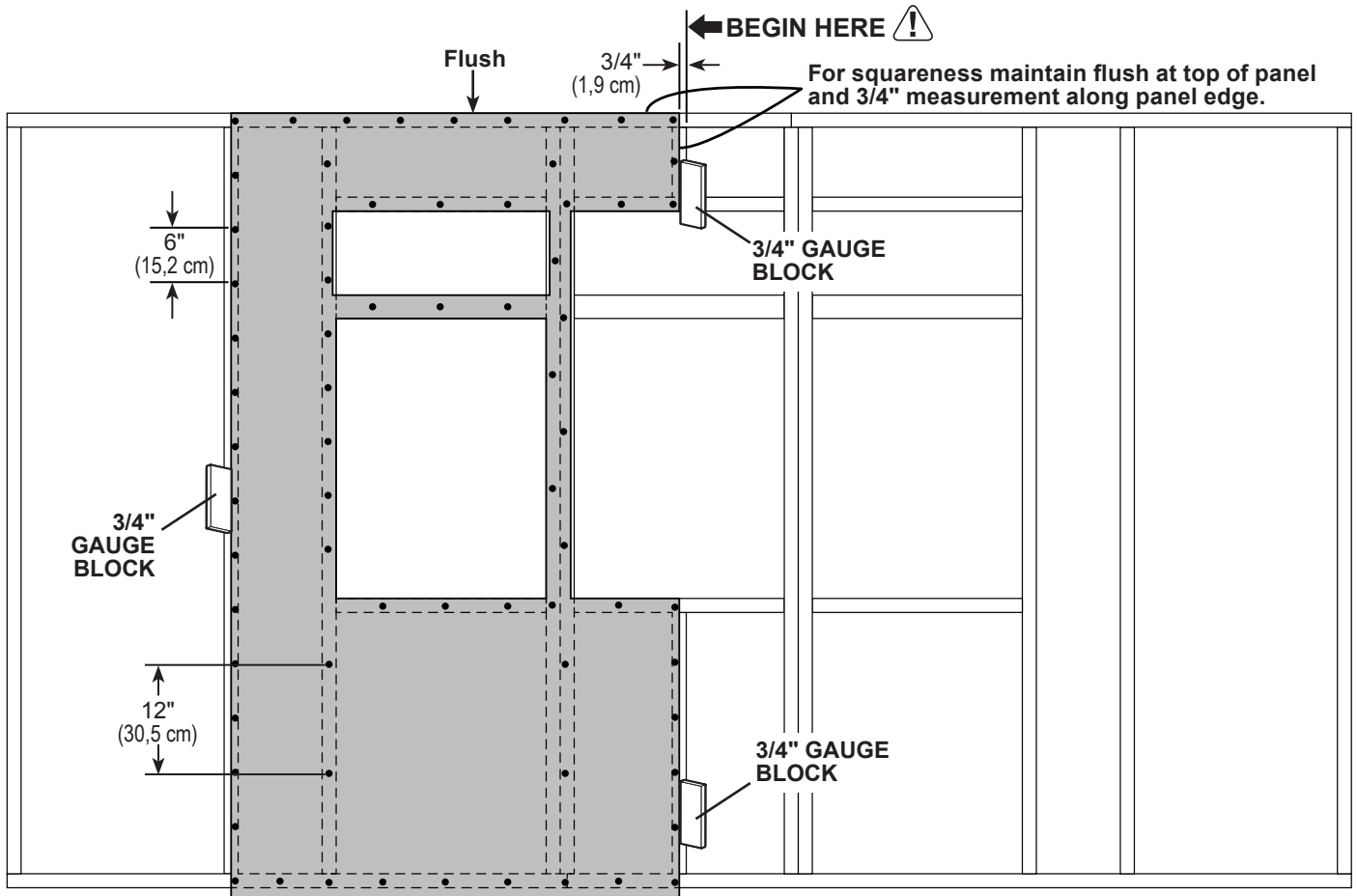

12' EAVE WALL WINDOW PANELS

PARTS REQUIRED:

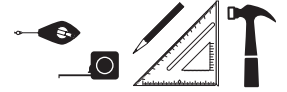
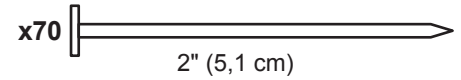
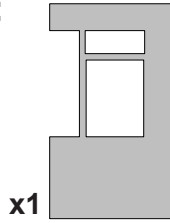

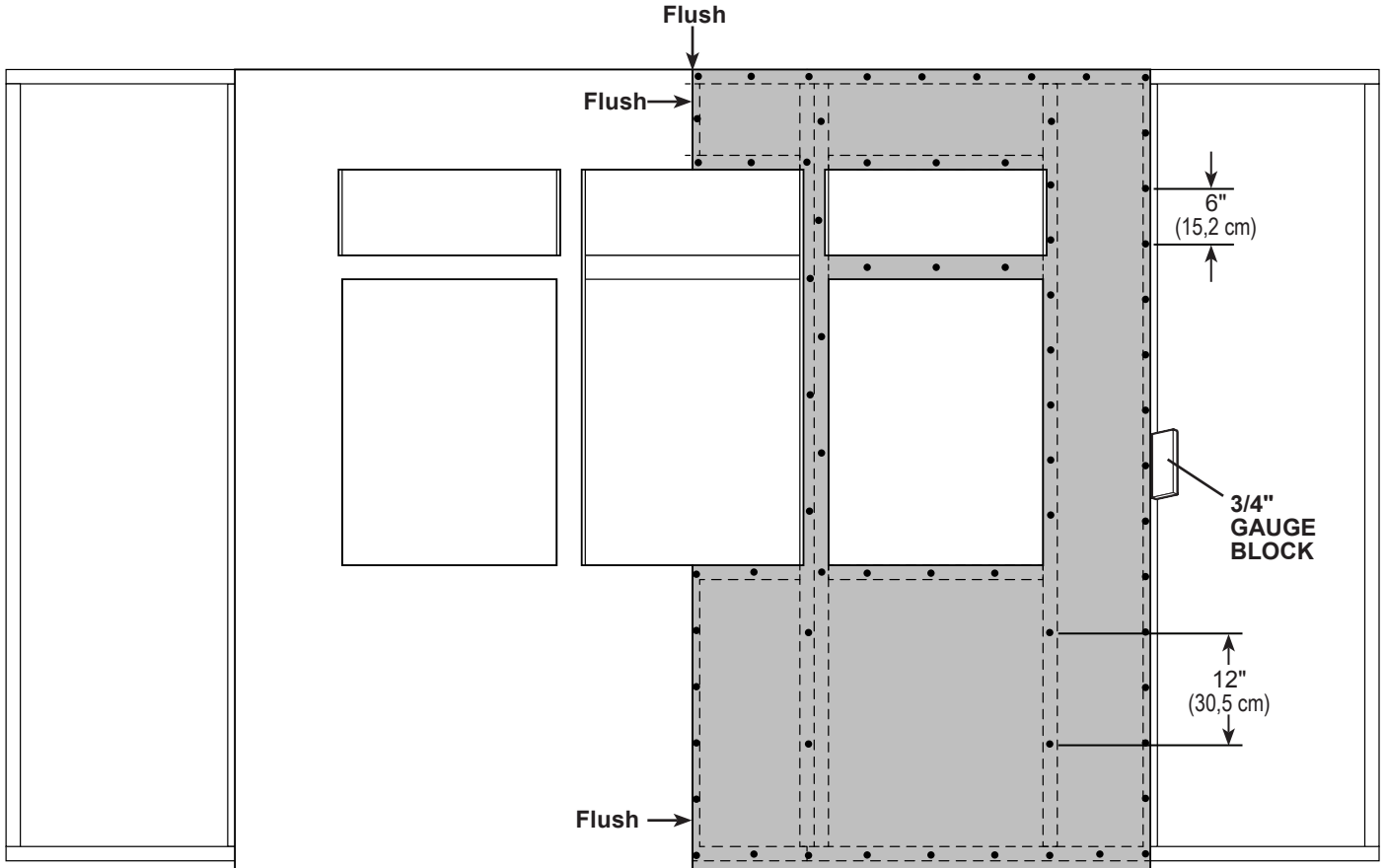

- 2 Place right 48" x 84" panel on wall frame flush to top of frame. Ensure panel maintains flush along edge and flush to top of installed panel as shown. Use the gauge block to ensure the 3/4" measurement on the wall stud. Secure panel with 2" nails spaced 6" apart along edges and 12" apart inside panel.



12' EAVE WALL WINDOW PANELS

PARTS REQUIRED:

x1 
 3/8" x 2-1/2" x 23-1/4"
 (1 x 6,3 x 59,1 cm)

x2 
 3/8 x 23-7/8 x 84"
 (1 x 60,6 x 213,4 cm)

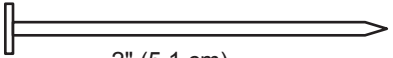
x72 
 2" (5,1 cm)

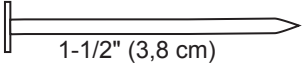
x3 
 1-1/2" (3,8 cm)

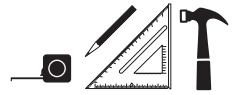

- Place (2) **23-7/8" x 84"** panels on wall frame flush to top of frame as shown. Flush panels to edges of installed panels. Center the **2-1/2" x 23-7/8"** filler panel between installed panels, as shown with primed side up. Secure panels with 2" nails spaced 6" apart along edges.

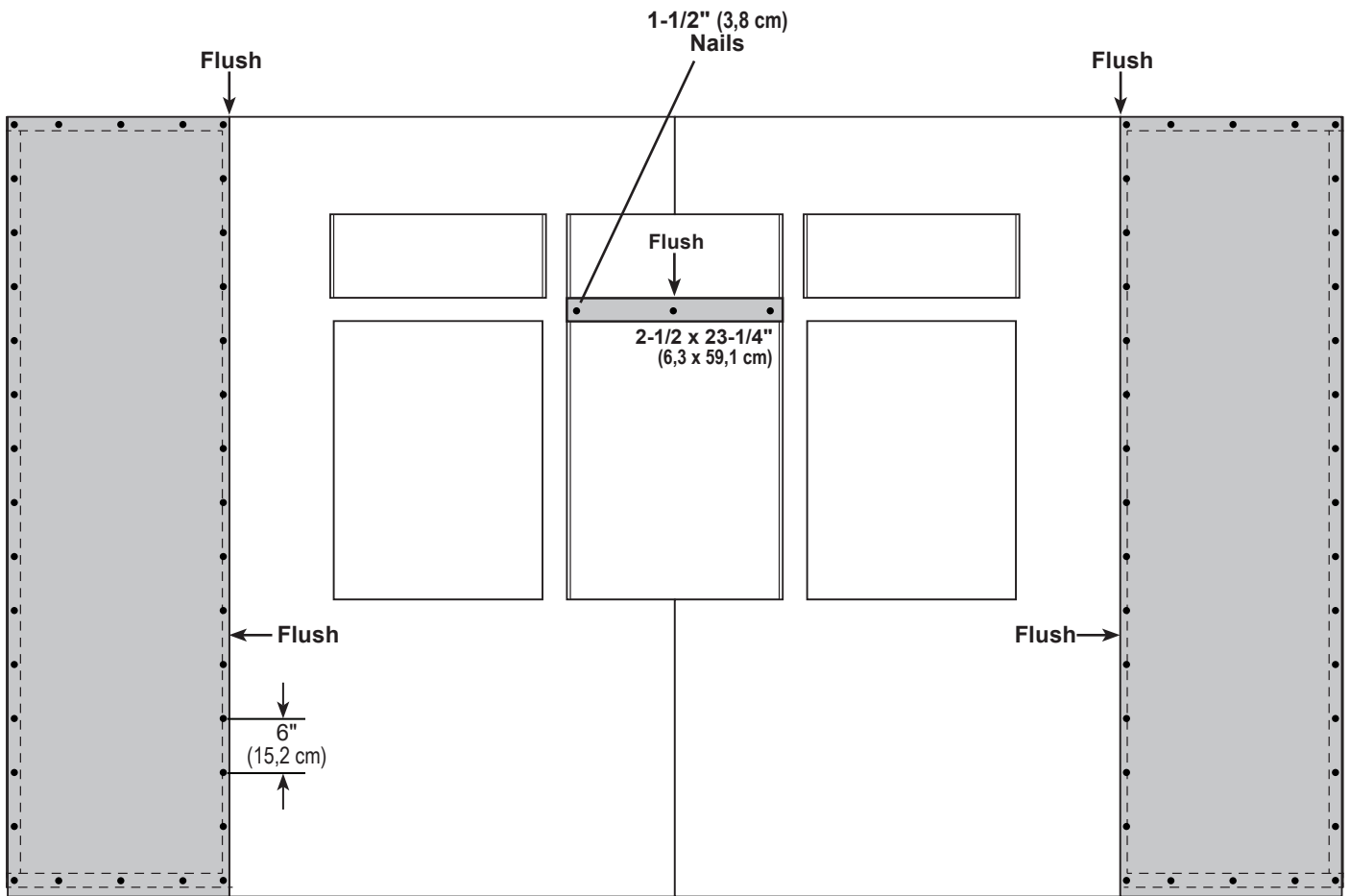

Carefully flip the 12' eave wall over.

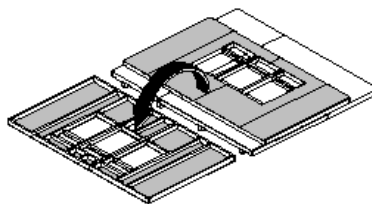

Your 12' window wall is now assembled.

GO TO Page 47 to continue building walls.

12' EAVE WALL DOOR FRAME

PARTS REQUIRED:

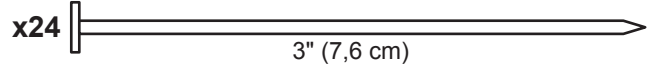

x2 **SX**
2 x 4 x 60" (5,1 x 10,3 x 152,4 cm)

x6 **TK**
2 x 4 x 80" (5,1 x 10,2 x 203,2 cm)

x2 **TO**
2 x 4 x 84" (5,1 x 10,2 x 213,4 cm)

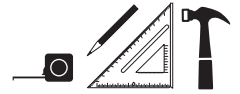

✓ BEGIN

- 1 Orient parts on edge on floor. Measure and mark.
Secure parts with (2) 3" nails at each mark.

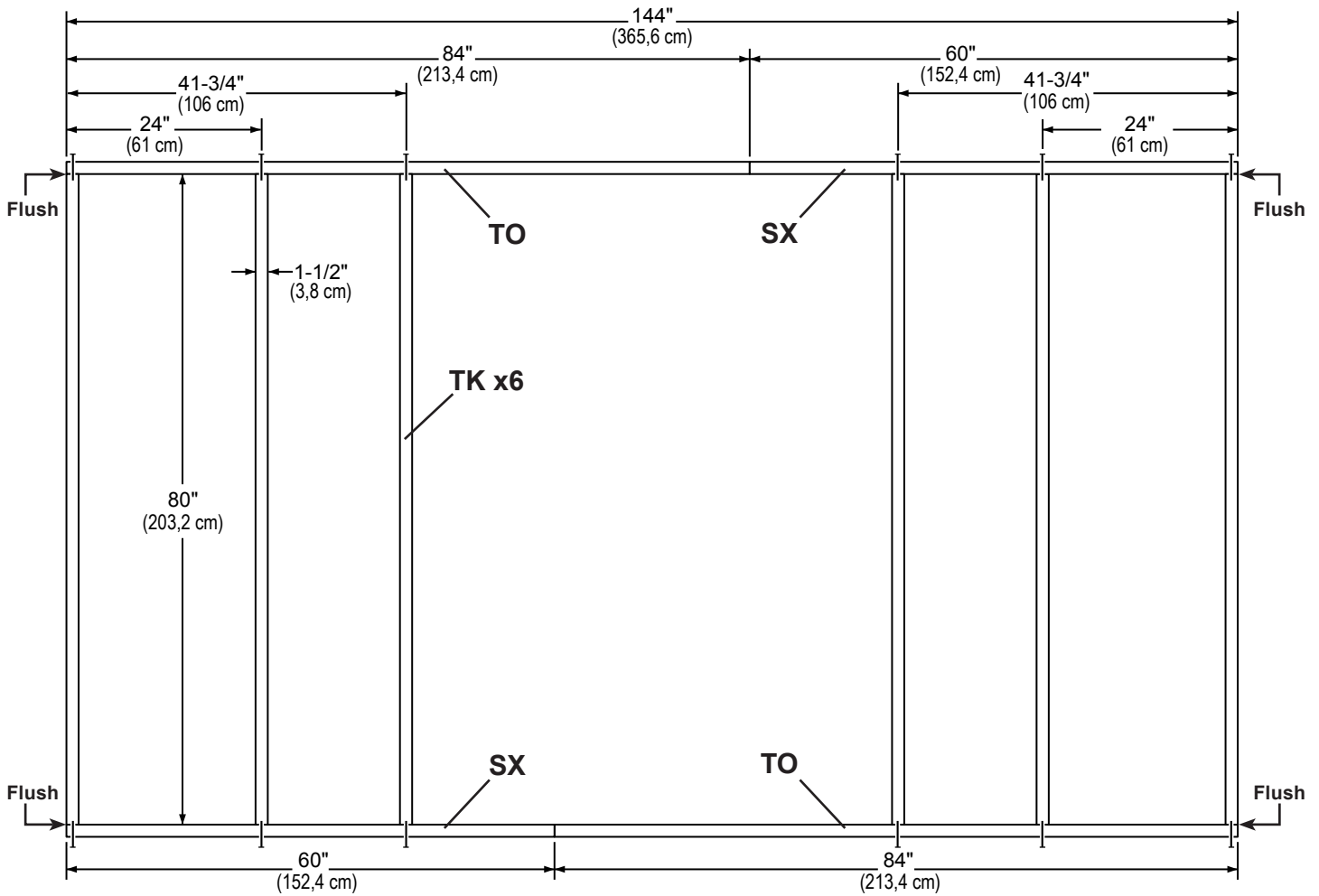
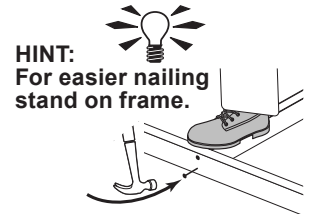

12' EAVE WALL DOOR FRAME

PARTS REQUIRED:

x5 **COA**
 2 x 4 x 8"
 (5,1 x 10,2 x 20,3 cm)

x1 **Header Assembly**
 2 x 4 x 59" (5,1 x 10,2 x 149,9 cm)

x2 **YFA**
 2 x 4 x 68-1/2" (5,1 x 10,2 x 174 cm)

x46  3" (7,6 cm)



2 Orient parts on edge on floor. Measure and mark.

Secure parts with (2) 3" nails at each mark and (4) 3" nails at top plate seam.

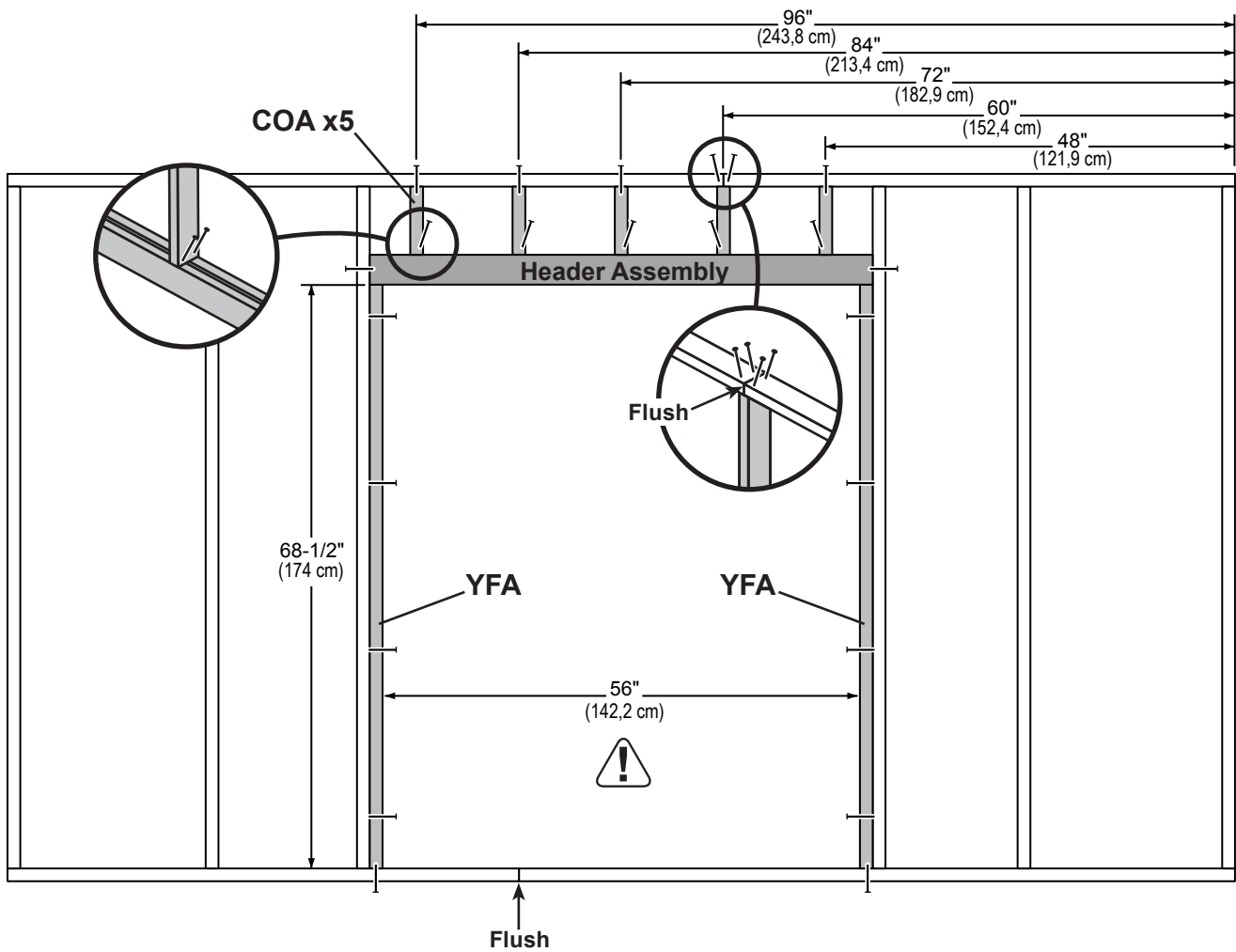

12' EAVE WALL DOOR PANELS

PARTS REQUIRED:

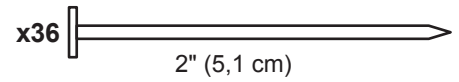
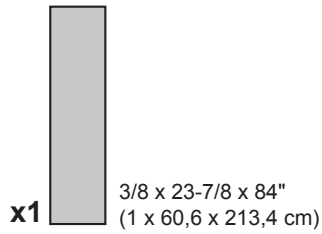

Install all panels with the primed side facing up.

✓ BEGIN

- 1 Place $23-7/8 \times 84"$ panel on wall frame flush to top of frame as shown. Use the gauge block to mark the $3/4"$ measurement on the wall stud.

Secure panel with 2" nails spaced 6" apart along edges.

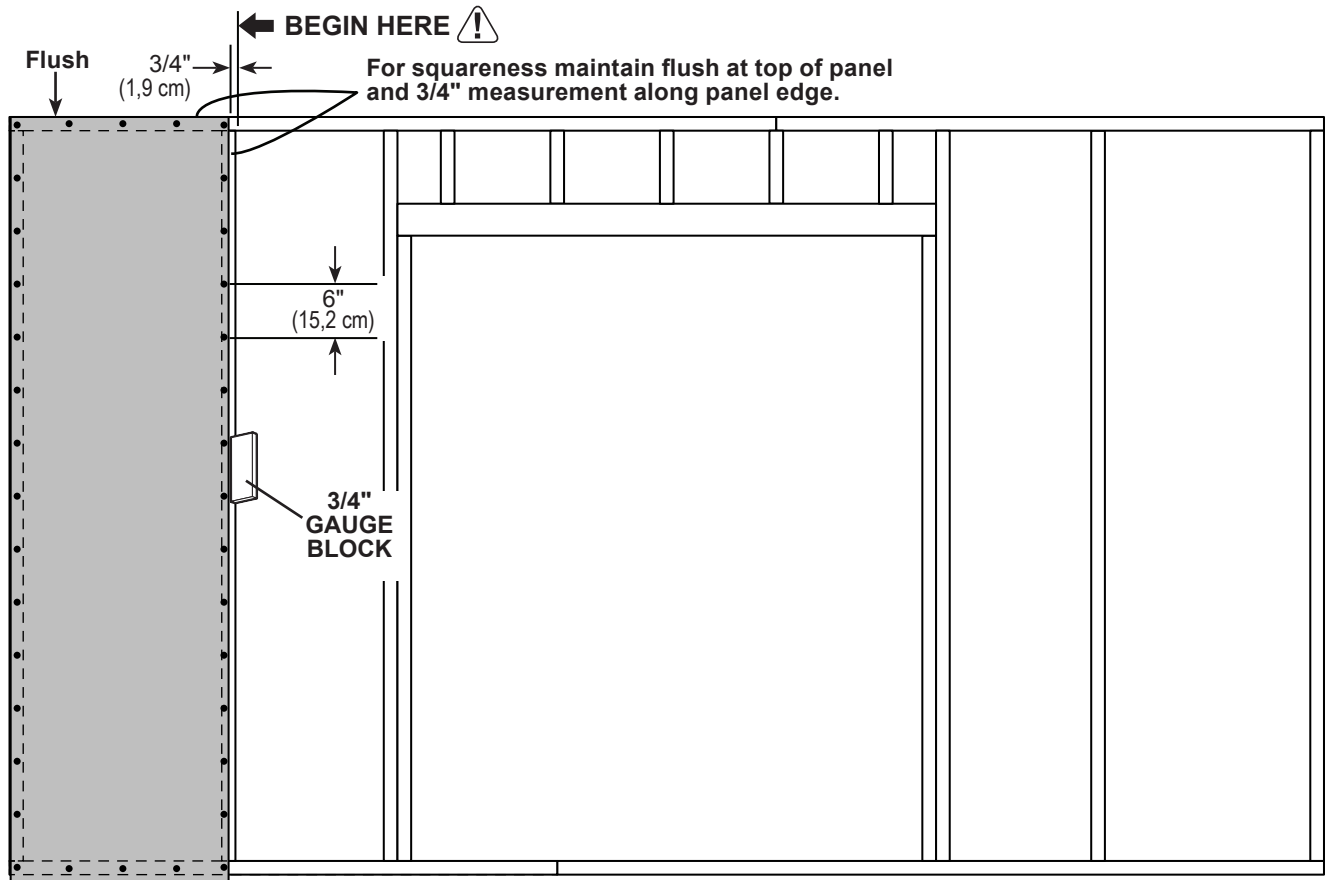

12' EAVE WALL DOOR PANELS

PARTS REQUIRED:

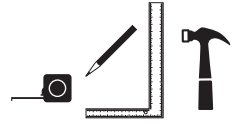
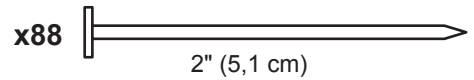
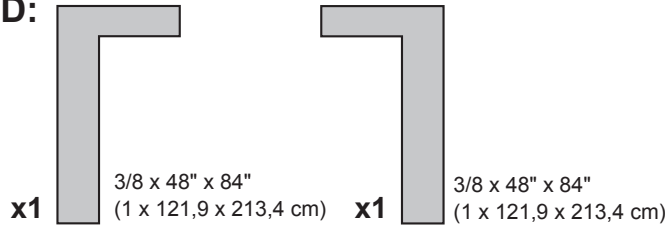

- Place left and right **48" x 84"** panels on wall frame flush to top of frame. Ensure the left **48" x 84"** panel is flush along edge of installed panel and both panels are flush to the top plate as shown. Use the gauge block to ensure the **3/4"** measurement on the wall stud. Secure panels with **2"** nails spaced **6"** apart along edges.

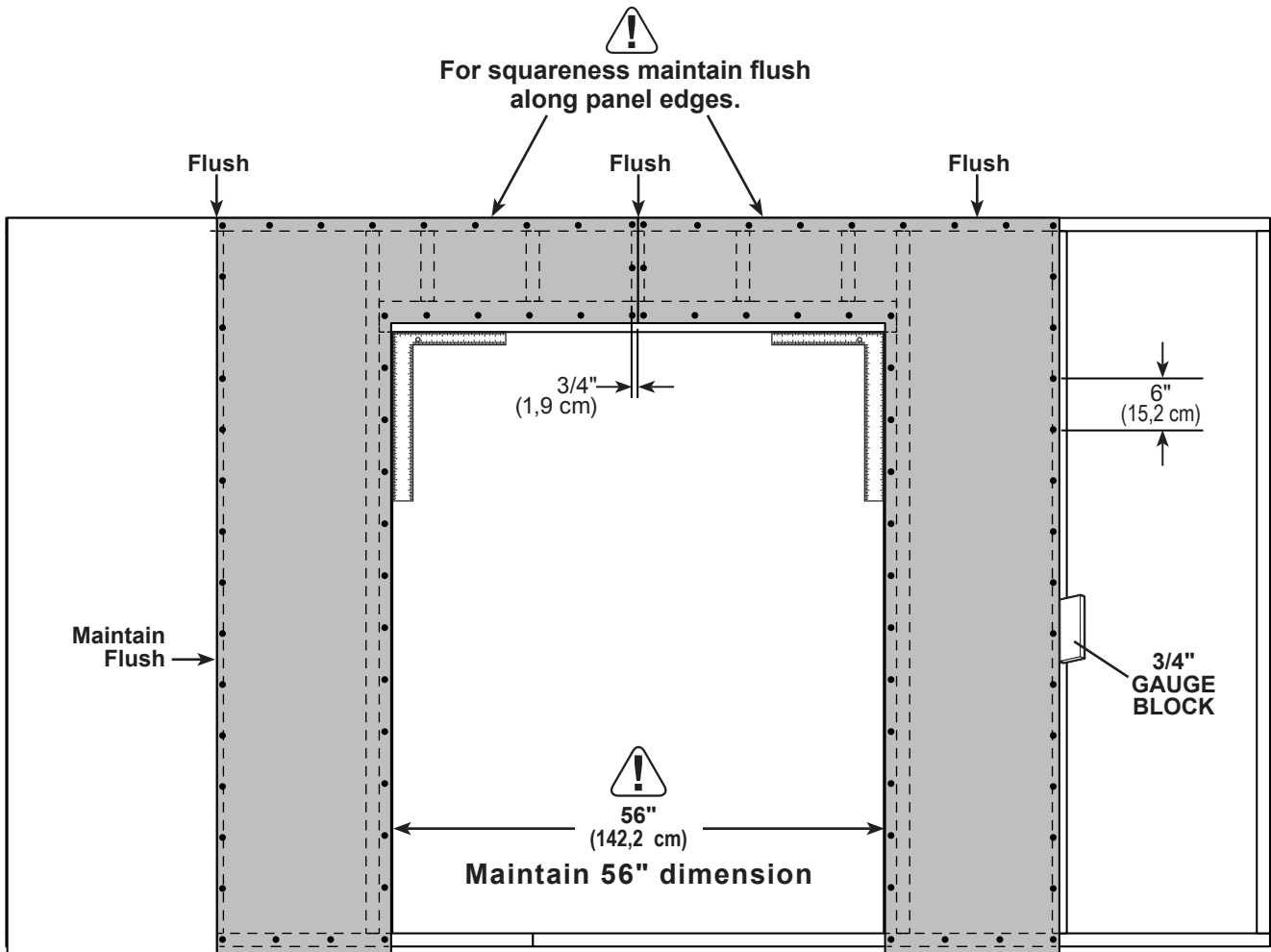

12' EAVE WALL DOOR PANELS

PARTS REQUIRED:

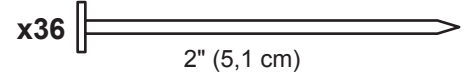
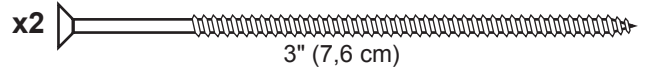
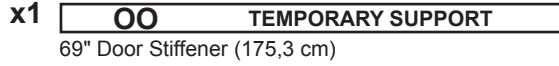
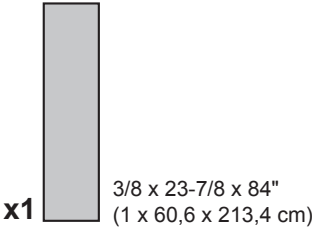

- Place **23-7/8 x 84"** panel on wall frame flush to top of frame as shown. Use the gauge block to mark the **3/4"** measurement on the wall stud. Secure panel with **2"** nails spaced **6"** apart along edges.

- Use **OO** as a temporary support brace to hold the **56"** (142,2 cm) measurement. Attach **OO** with two **3"** screws into studs as shown.

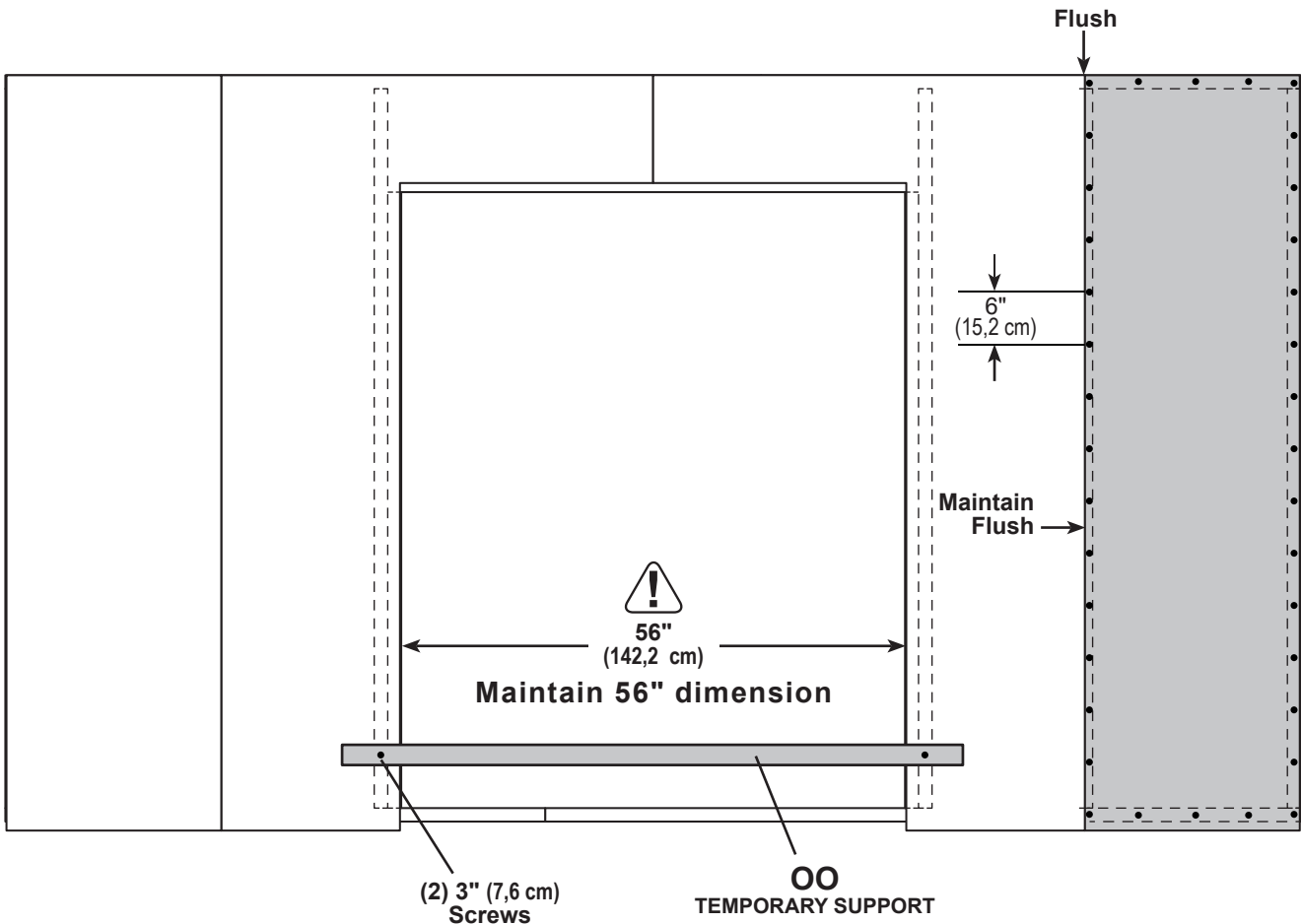

Carefully flip the 12' eave wall over.

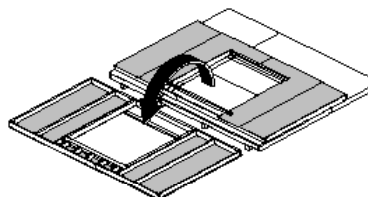

FINISH

Your eave wall with door is now finished.

10' GABLE WALL WINDOW FRAME

PARTS REQUIRED:

x2 **STL**
2 x 4 x 44-1/2" (5,1 x 10,2 x 113 cm)

x2 **YFA**
2 x 4 x 68-1/2" (5,1 x 10,2 x 174 cm)

x4 **TK**
2 x 4 x 80" (5,1 x 10,2 x 203,2 cm)

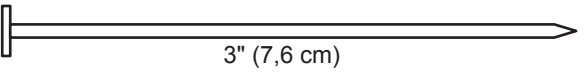
x28  3" (7,6 cm)

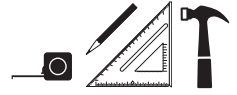
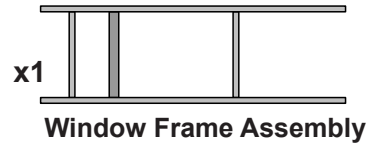

✓ BEGIN

- 1 Orient parts on edge on floor, stagger placement at seams. Measure and mark. Position the window frame assembly so LV is elevated above the floor (**Fig. A**).

Secure parts with (2) 3" nails at each mark and (4) nails at seams

 **HINT:**
For easier nailing stand on frame.

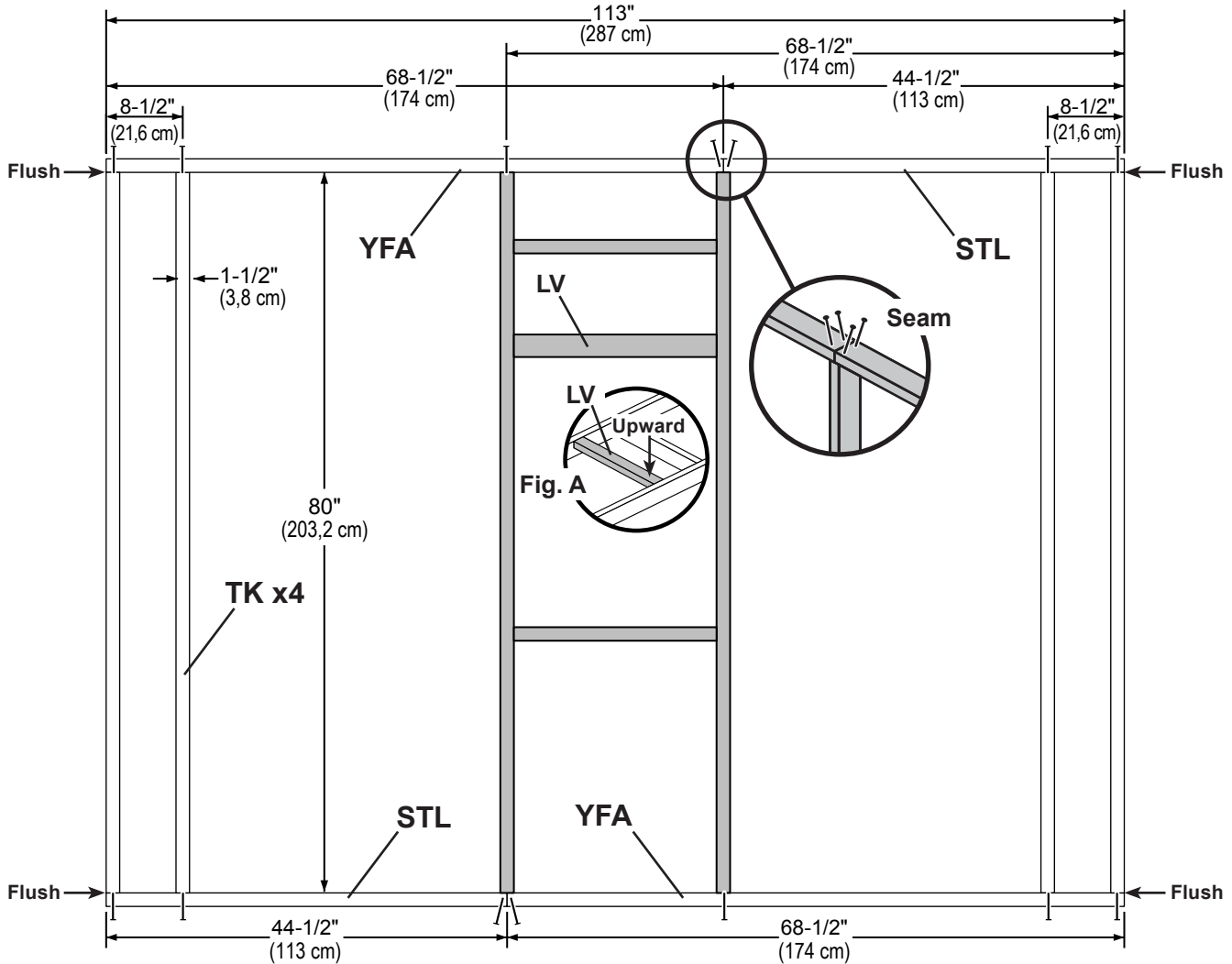
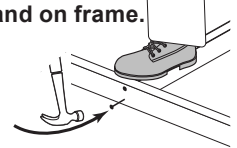

10' GABLE WALL WINDOW FRAME

PARTS REQUIRED:

x1 **AMA**
2 x 4 x 7-1/2" (5,1 x 10,2 x 35,6 cm)

x1 **RR**
2 x 4 x 28" (5,1 x 10,2 x 71,1 cm)

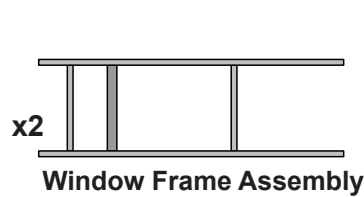

x48 3" (7,6 cm)



- 2 Position the (2) window frame assemblies flush to the installed window frame. Ensure that part **LV** is elevated above the floor (**Fig. A**). Center parts **AMA** and **RR** in the middle window frame assembly. Measure and mark. Secure parts with (2) 3" nails at each at each connection and as shown.

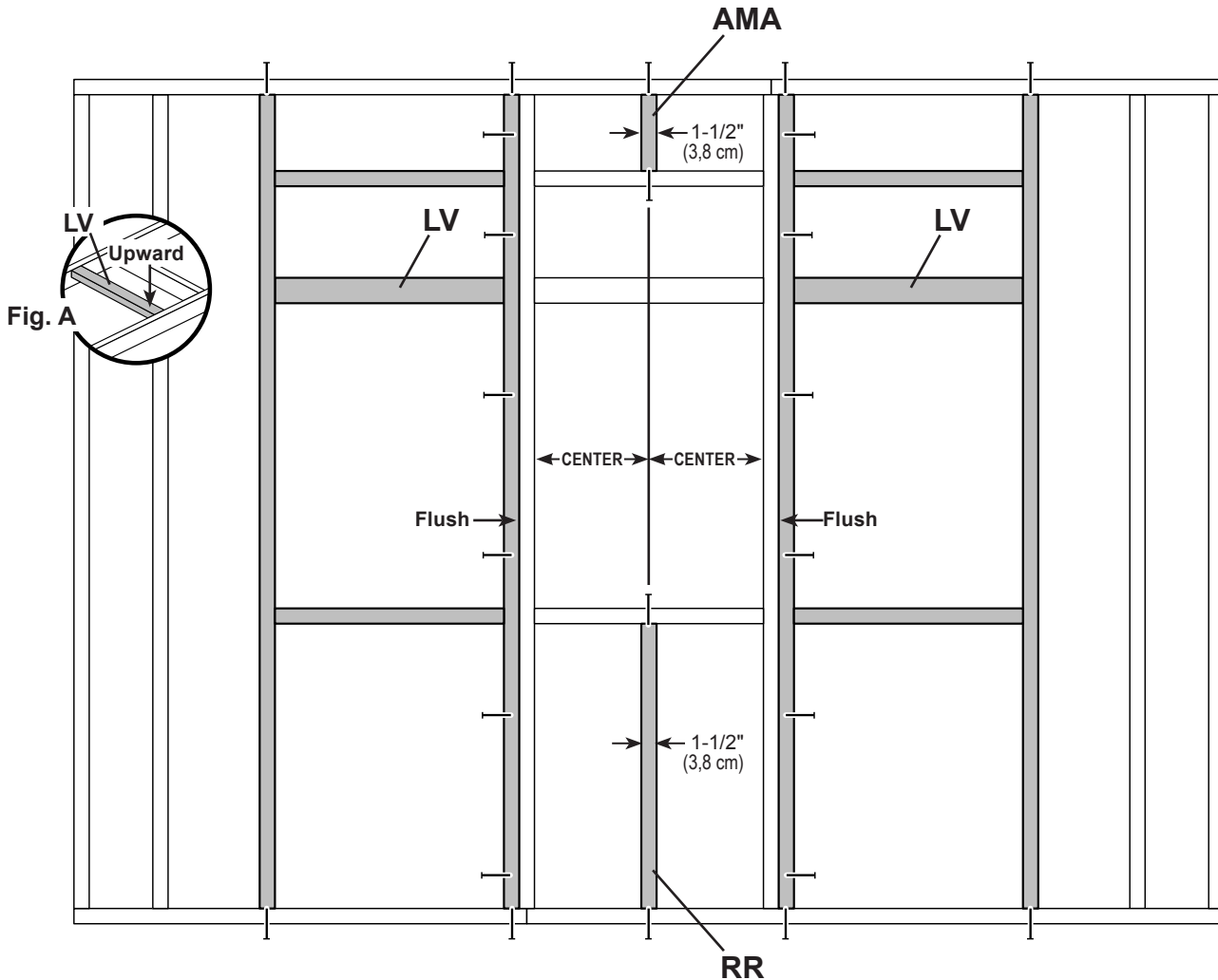

10' GABLE WALL WINDOW PANELS

PARTS REQUIRED:

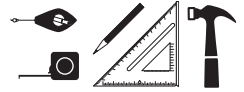
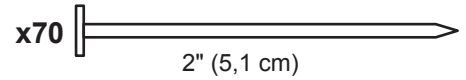
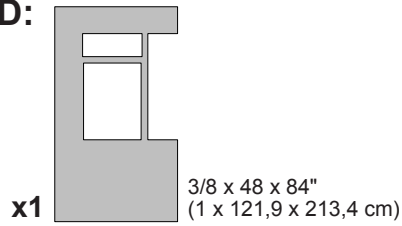

Install all panels with the primed side facing up.

✓ BEGIN

- 1** Place left **48 x 84"** panel on wall frame flush to top of frame.
Ensure panel maintains flush along edge and flush to top of framing as shown.
Use the gauge block to ensure the **3/4"** measurement on the wall stud.
Secure panel with **2"** nails spaced **6"** apart along edges and **12"** apart inside panel.

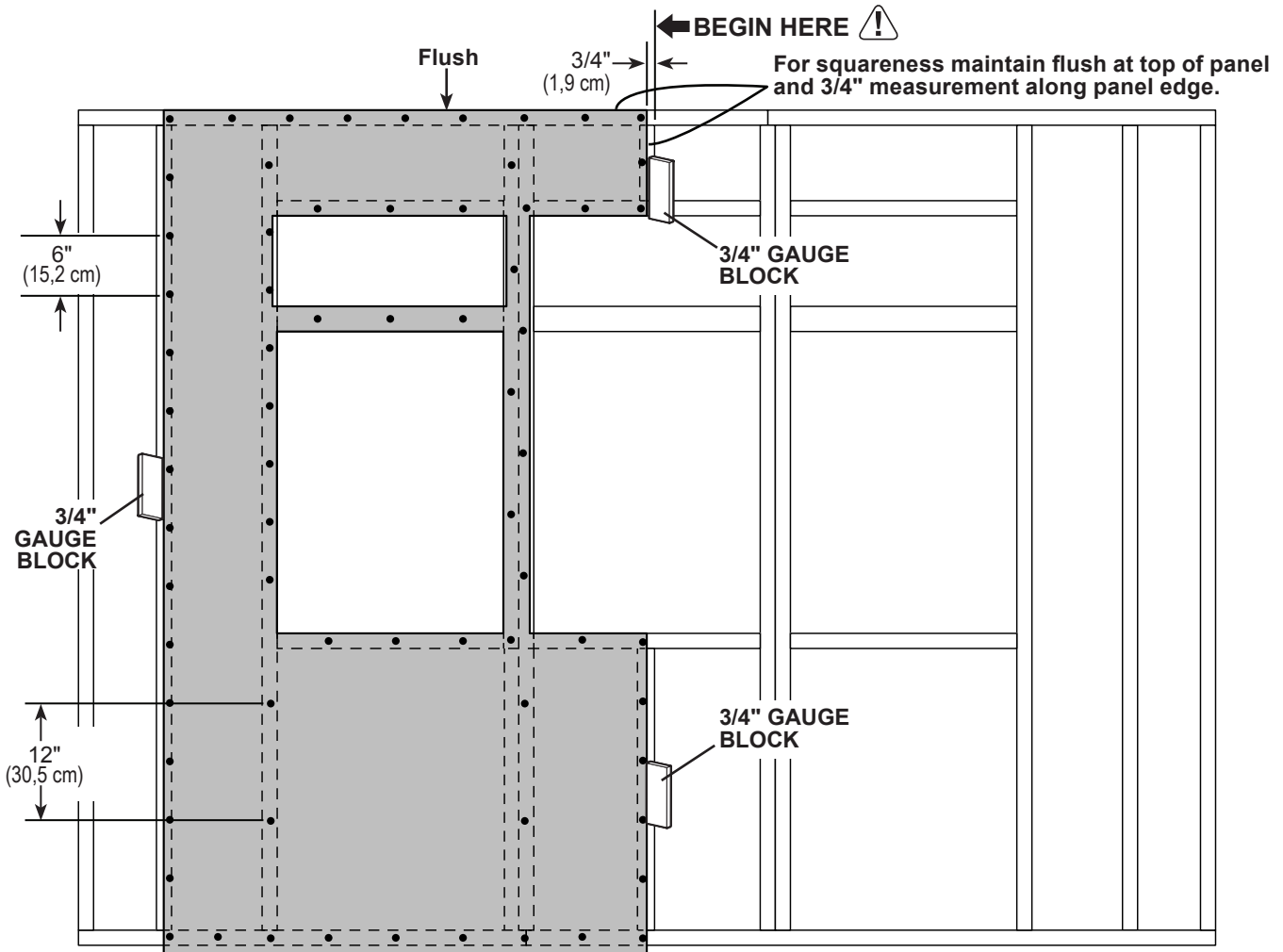

10' GABLE WALL WINDOW PANELS

PARTS REQUIRED:

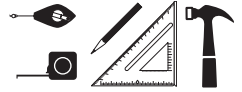
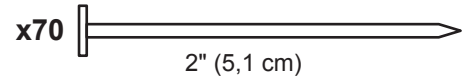
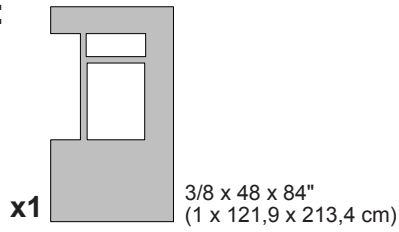

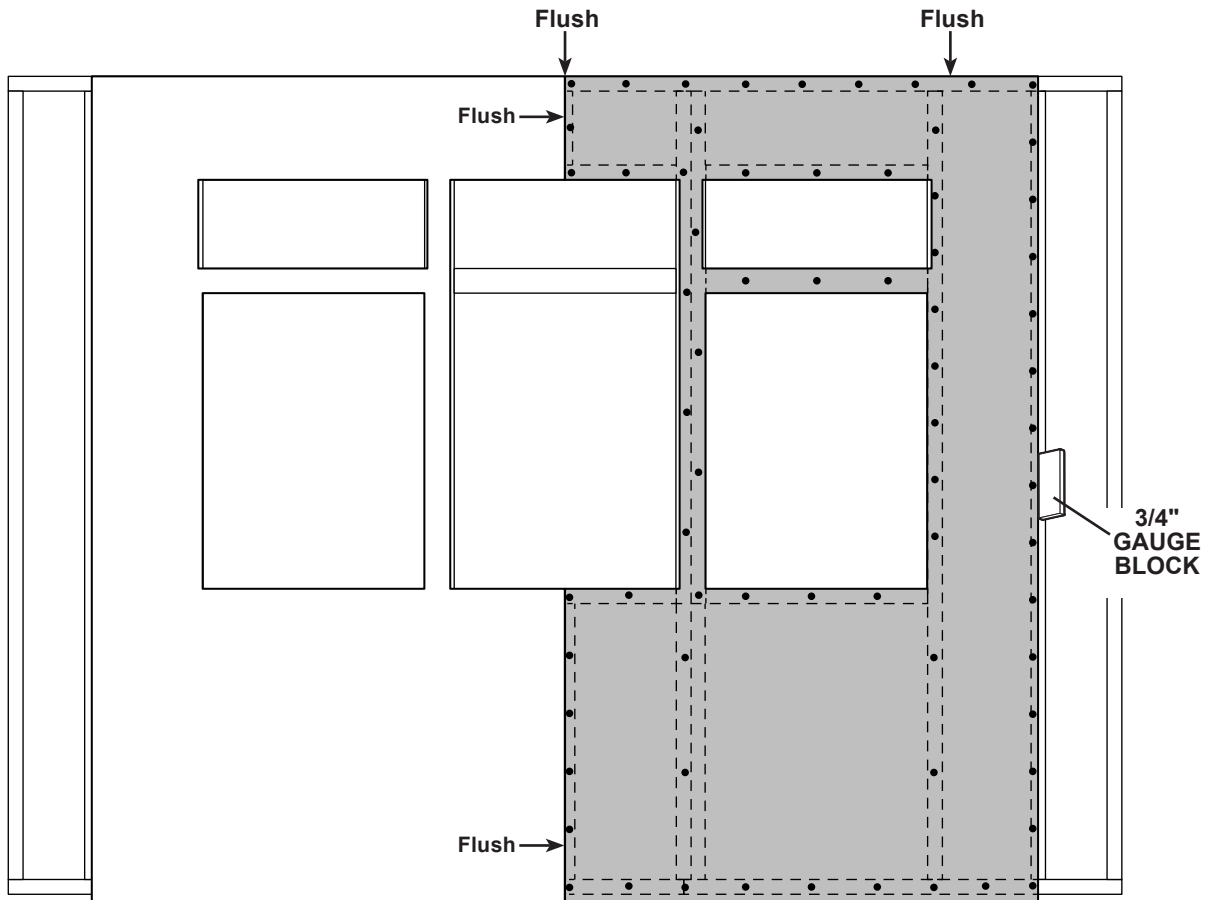

- 2 Place right **48 x 84"** panel on wall frame flush to top of frame. Ensure panel maintains flush along edge and flush to top of installed panel as shown. Use the gauge block to ensure the **3/4"** measurement on the wall stud. Secure panel with **2"** nails spaced **6"** apart along edges and **12"** apart inside panel.



10' GABLE WALL WINDOW PANELS

PARTS REQUIRED:

x1 
 3/8" x 2-1/2" x 23-1/4"
 (1 x 6,3 x 59,1 cm)

x2 
 3/8" x 11-7/8" x 84"
 (1 x 30,2 x 213,4 cm)

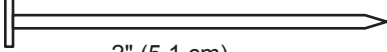
x64 
 2" (5,1 cm)

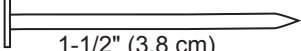
x4 
 1-1/2" (3,8 cm)

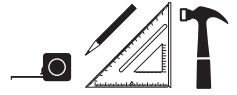

- Place (2) 11-7/8 x 84" panels on wall frame flush to top of frame. Flush panels to edges of installed panels. Center the 2-1/2 x 23-7/8" filler panel between installed panels, as shown with primed side up. Secure panels with 2" nails spaced 6" apart along edges.

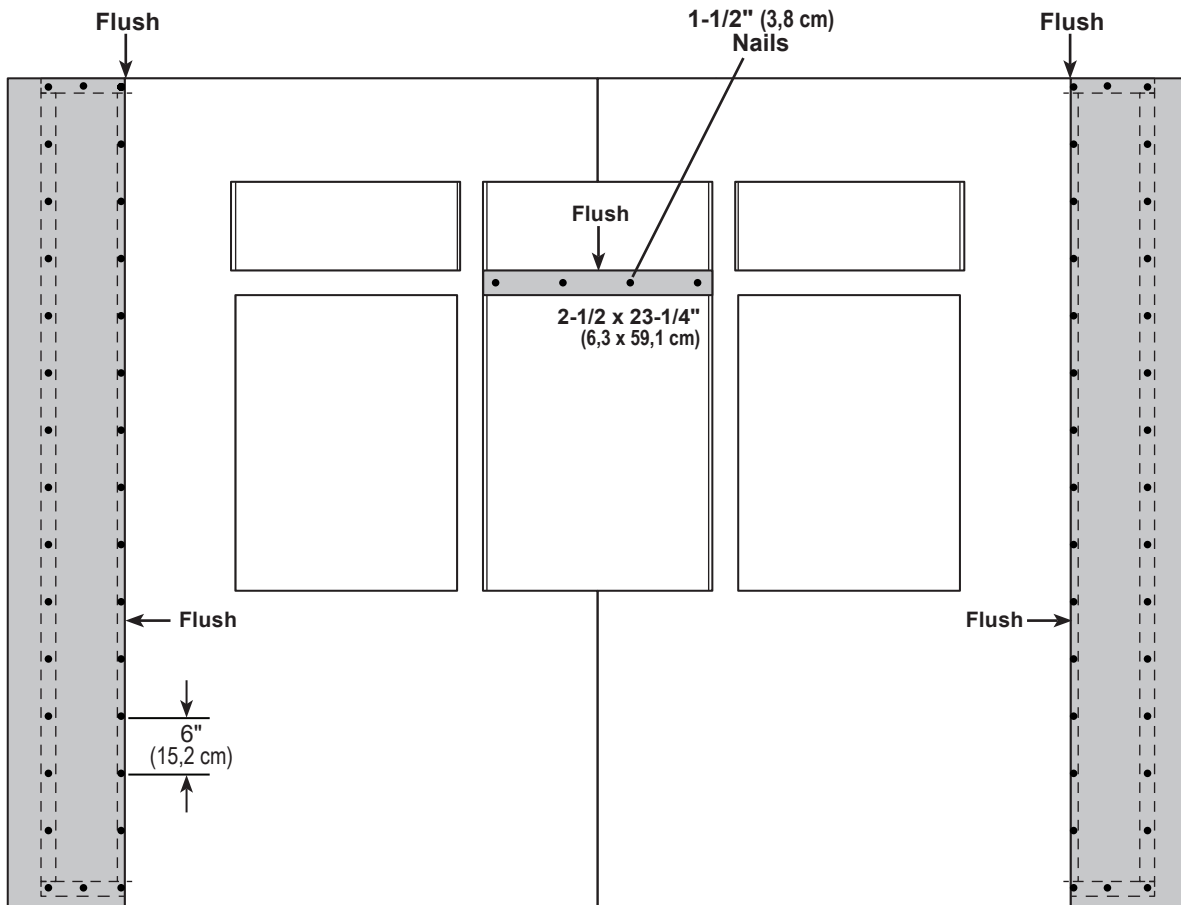

Carefully flip the 10' gable wall over.

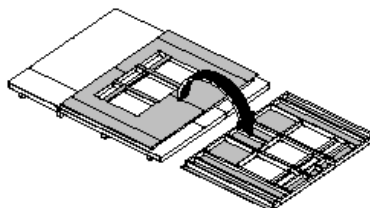

Your 10' window wall is now assembled.

Continue building walls on next page.

12' EAVE WALL FRAME

PARTS REQUIRED:

- x2 **SP** 2 x 4 x 48" (5,1 x 10,2 x 121,9 cm)
- x7 **TK** 2 x 4 x 80" (5,1 x 10,2 x 203,2 cm)
- x2 **TP** 2 x 4 x 96" (5,1 x 10,2 x 243,8 cm)

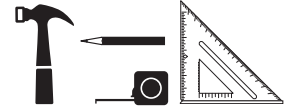
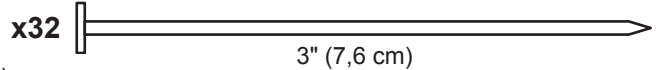

BEGIN

- 1 Orient parts on edge on floor. Stagger placement at seams. Measure and mark. Secure with (2) 3" nails at each mark and (4) 3" nails at seams

HINT: For easier nailing stand on frame.

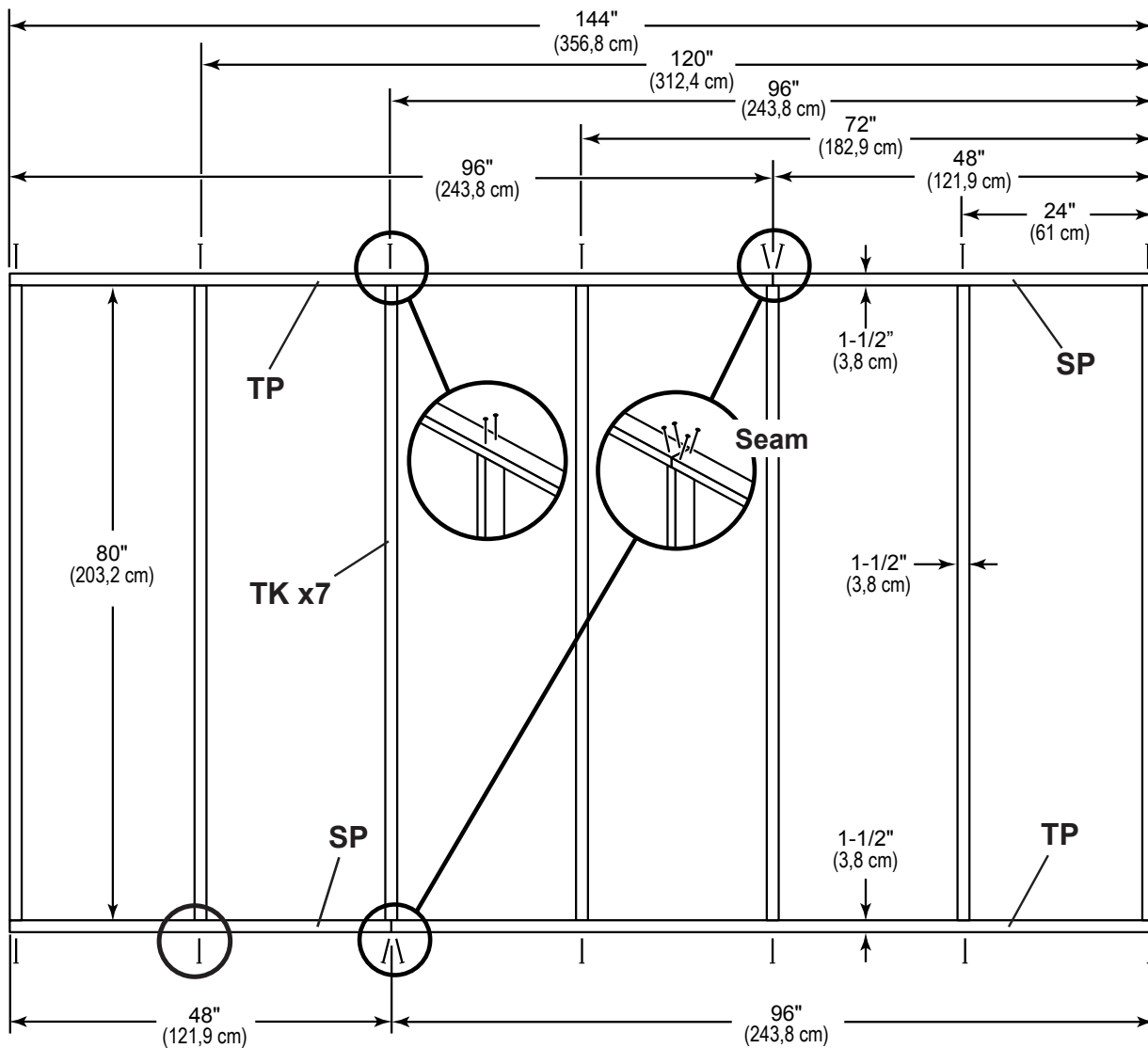
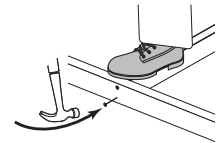

12' EAVE WALL PANELS

PARTS REQUIRED:

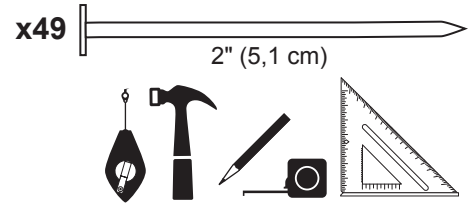

Install all panels with the primed side facing up.



Ensure your wall frame is square by installing one panel and squaring frame.

✓ BEGIN

- 1 Place **48 x 84"** panel on wall frame flush to top of frame as shown. Use the gauge block to mark the **3/4"** measurement on the wall stud. Secure panel with (2) 2" nails in the corners (**Fig. A**).
- 2 Move to the opposite end. Using the long edge of the panel as a lever move the panel side-to-side until you have a **3/4"** measurement on the wall stud. Secure corner with (2) 2" nails (**Fig. B**).

Nail the panel with 2" nails spaced 6" apart on edges and 12" apart inside panel.

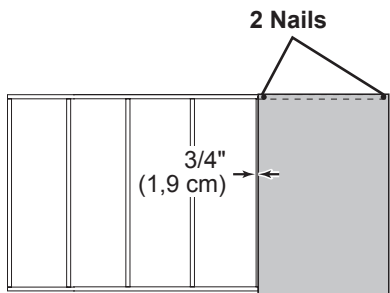

Fig. A

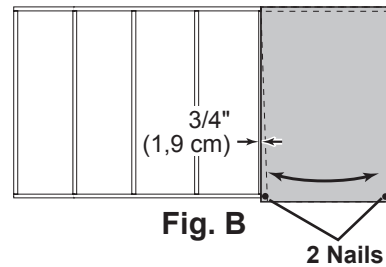
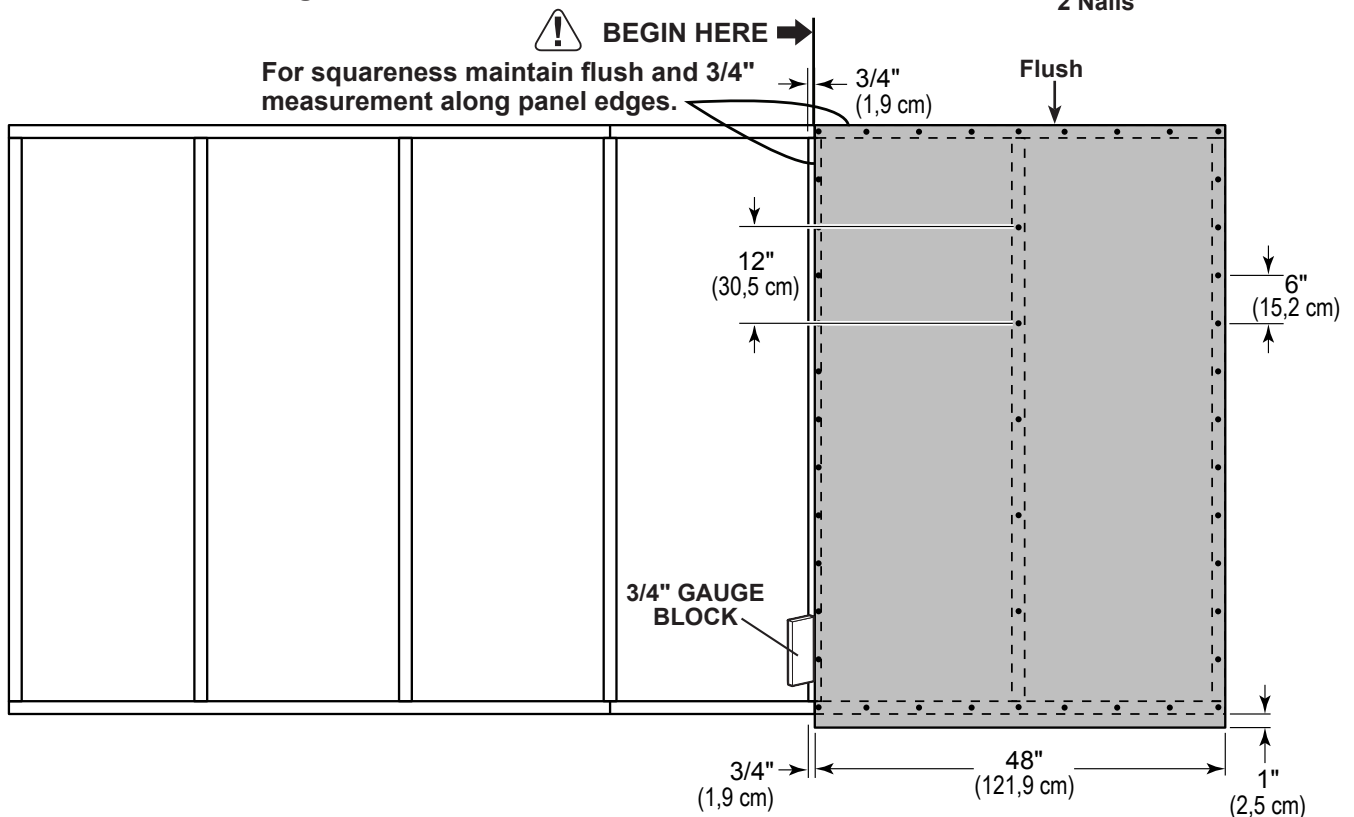
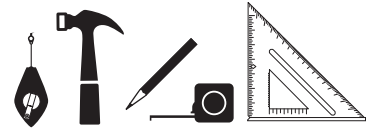
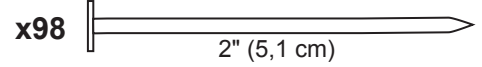
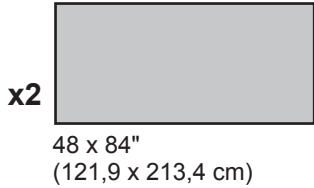

Fig. B



12' EAVE WALL PANELS

PARTS REQUIRED:



- 3** Place center **48" x 84"** panel on frame. Flush panel to top of top plate and to installed panel.

Secure with 2" nails spaced 6" apart on edges and 12" apart inside panel.

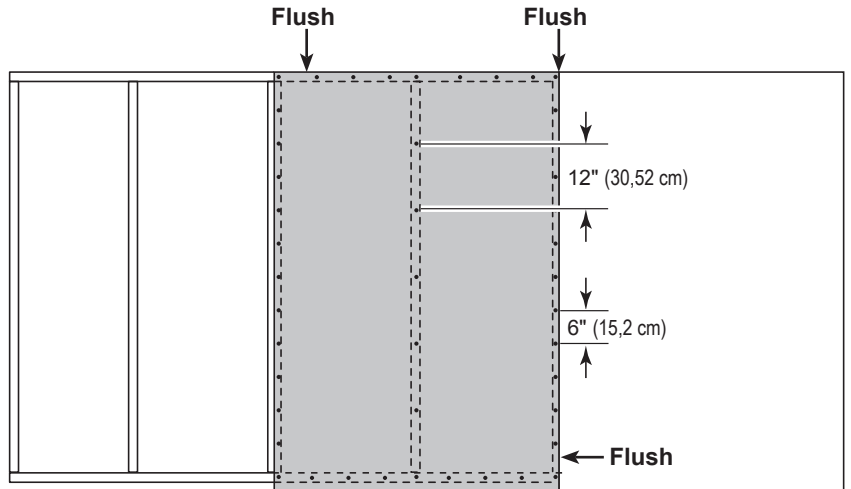

- 4** Place end **48" x 84"** panel on frame. Flush panel to top of top plate and to installed panel.

Secure with 2" nails spaced 6" apart on edges and 12" apart inside panel.

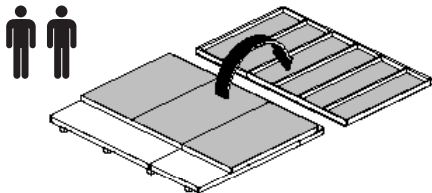
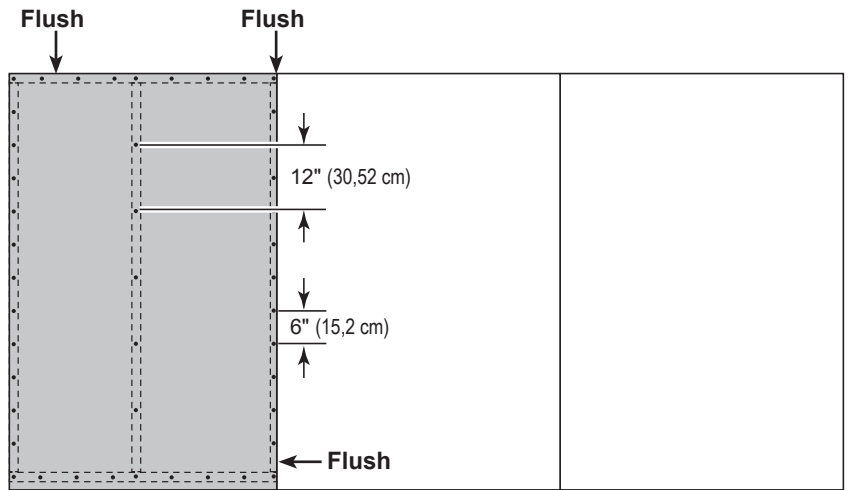

Carefully flip the eave wall over.



You have finished building your 12' eave wall.

GABLE END WALL

PARTS REQUIRED:

x6 **TK**
2 x 4 x 80" (5,1 x 10,2 x 203,2 cm)

x2 **YFA**
2 x 4 x 68-1/2" (5,1 x 10,2 x 174 cm)

x2 **STL**
2 x 4 x 44-1/2" (5,1 x 10,2 x 113 cm)

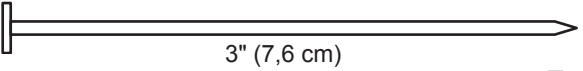
x28  3" (7,6 cm)



✓ **BEGIN**

1 Orient parts on edge on floor. Measure and mark.

Secure parts with (2) 3" nails at each mark and (4) nails at seams.

HINT:  For easier nailing stand on frame.

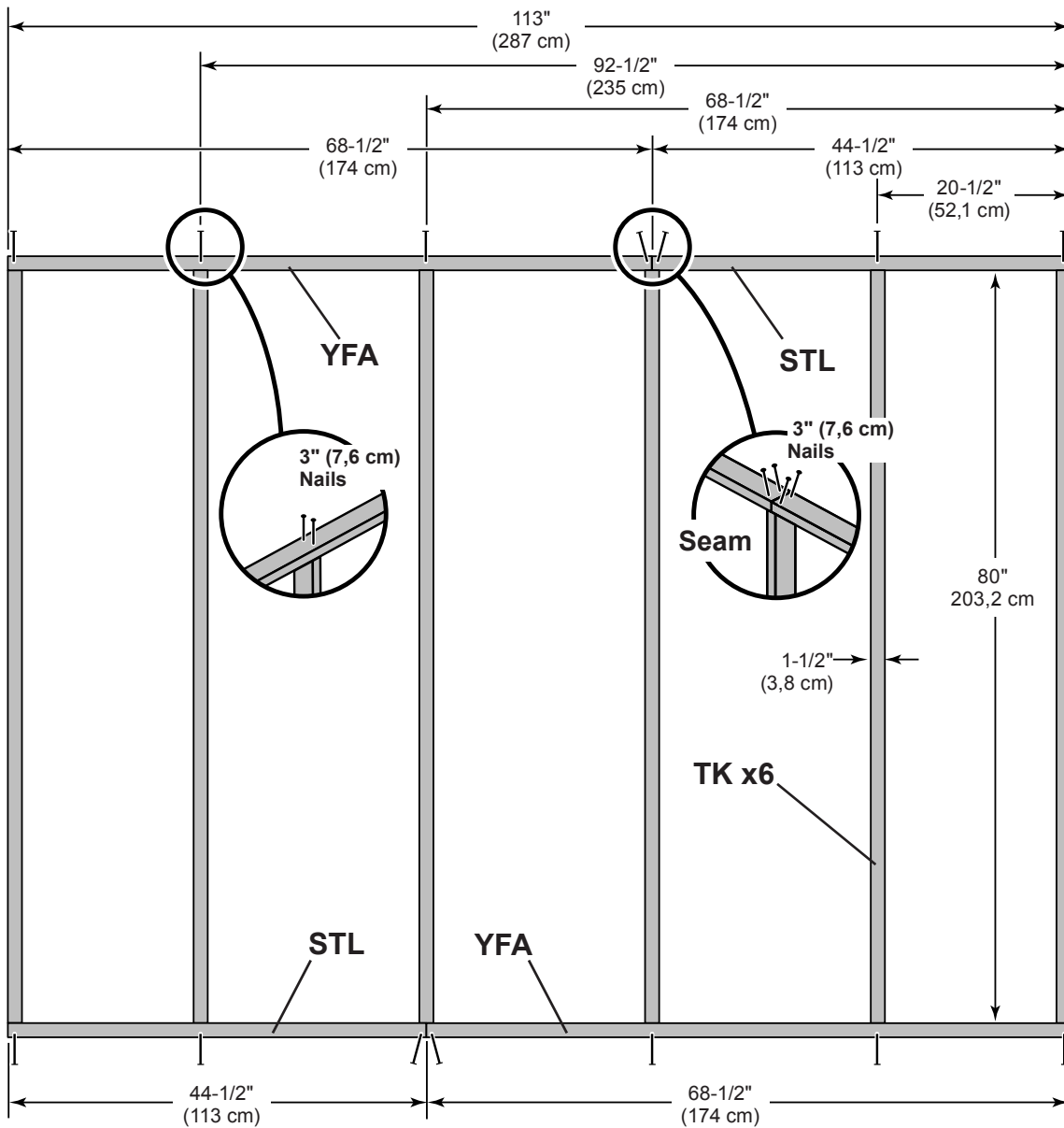
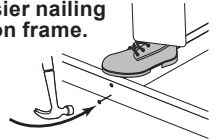

GABLE END WALL

PARTS REQUIRED:

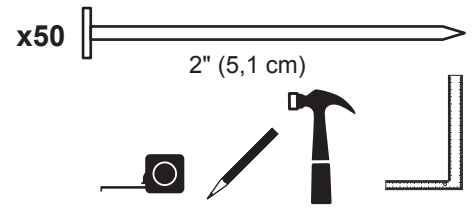

Install all panels with the primed side facing up.

2 Place 48" x 84" panel on frame, flush at top and with a 3/4" gap on right side.

 **Maintain 3/4" measurement along edge.**

Secure panel to frame with 2" nails spaced 6" apart along edges and 12" inside panel..

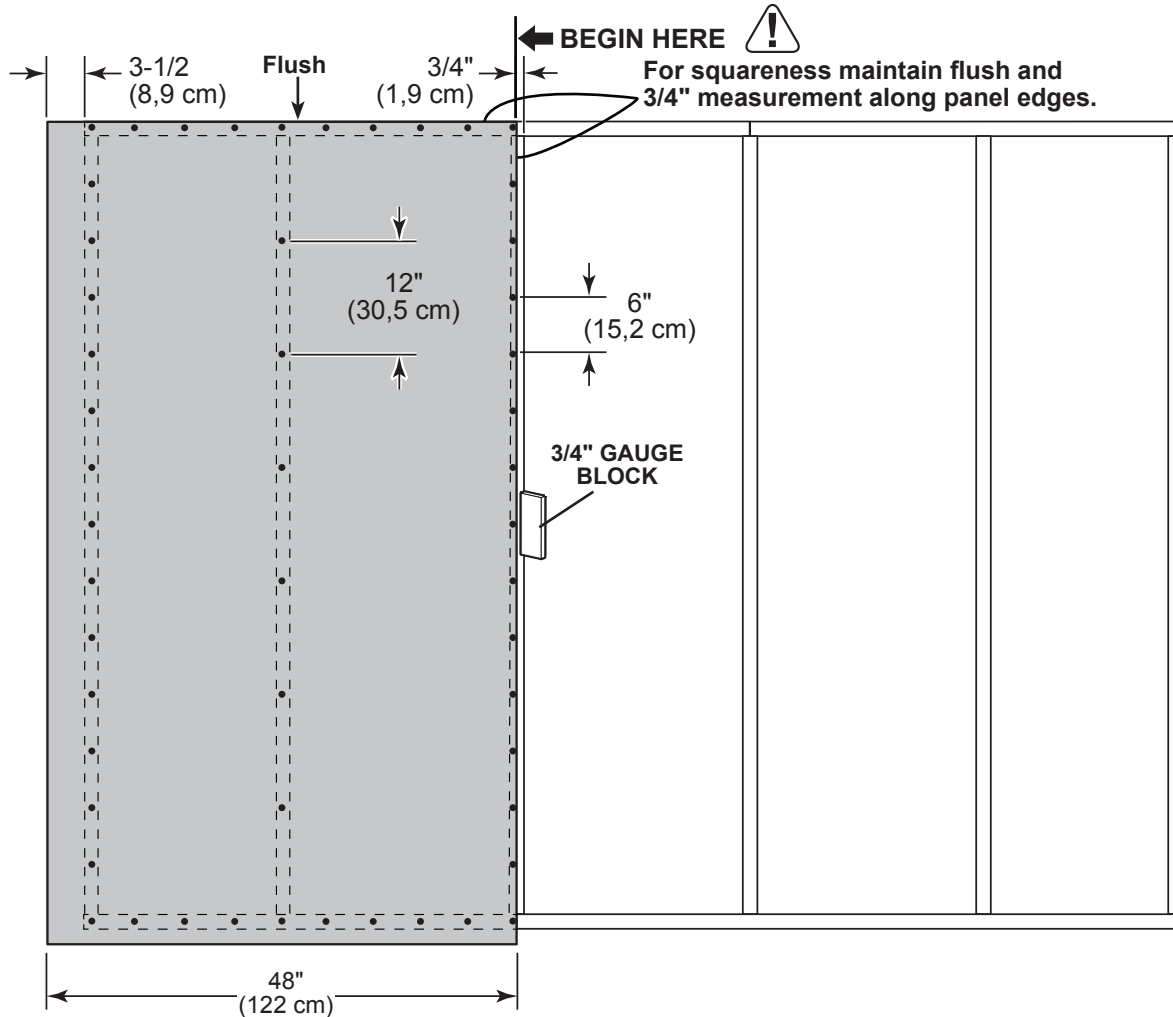

GABLE END WALL

PARTS REQUIRED:

x1  23-7/8 x 84"
 (60,6 x 213,4 cm)

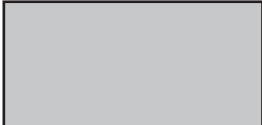
x1  48 x 84"
 (122 x 213,4 cm)

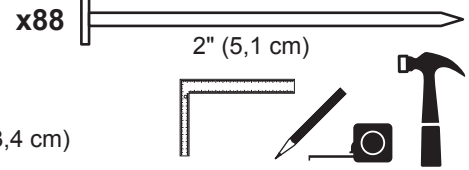

3 Install 23-7/8" x 84" and 48" x 84" flush with installed panels as shown.

Ensure panels are flush at top.

Secure with 2" nails spaced 6" apart on edges and 12" inside panel.

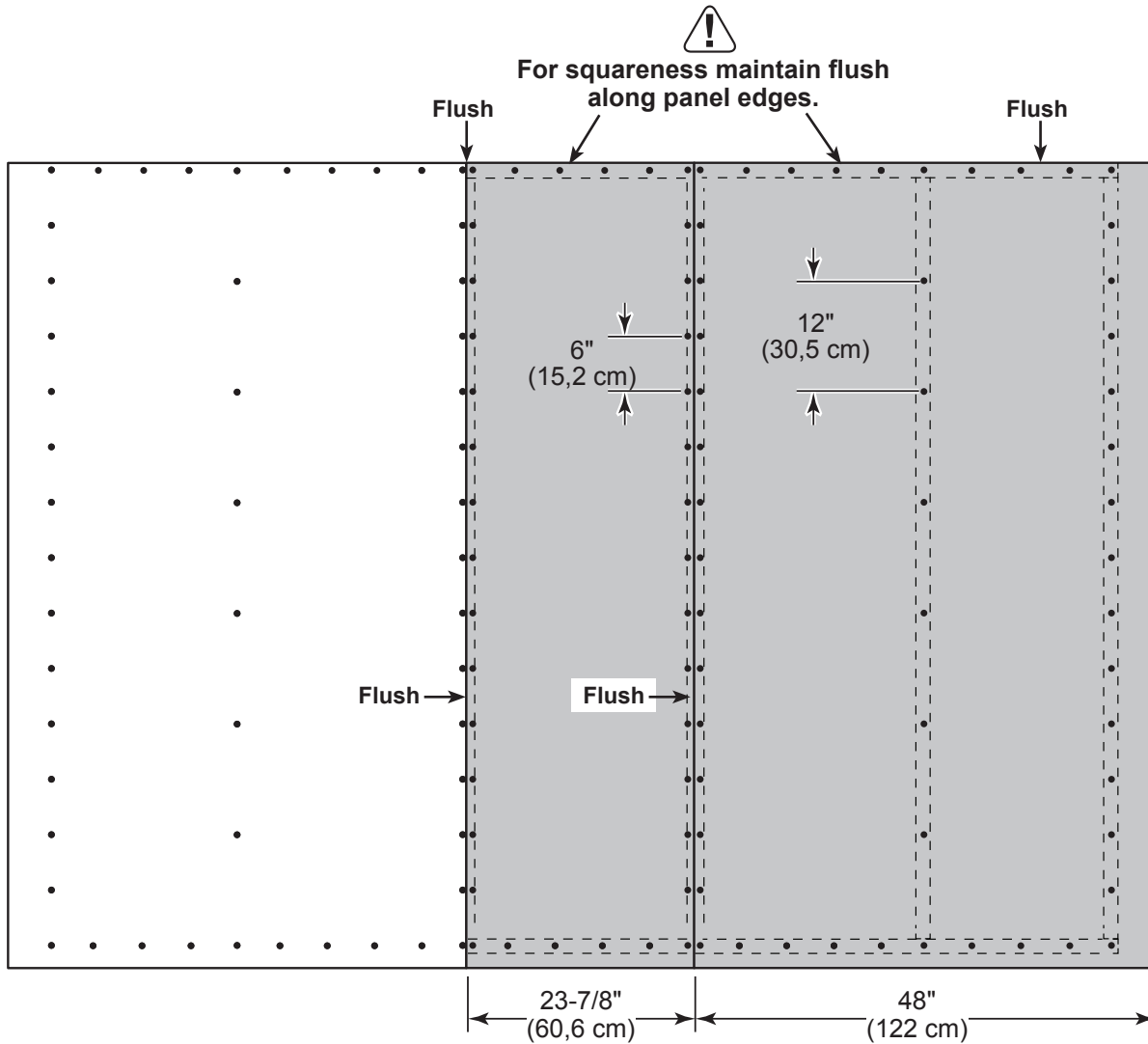

Carefully flip the gable end wall over.



You have finished building your gable end wall.

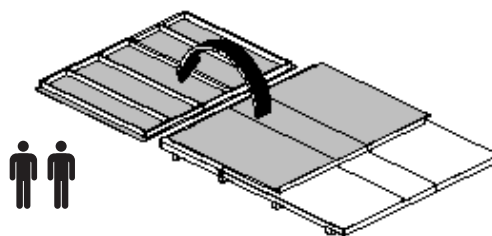

12' EAVE WALL INSTALLATION

PARTS REQUIRED:

x1 **OO** TEMPORARY SUPPORT
69" (175,3) Door Stiffener

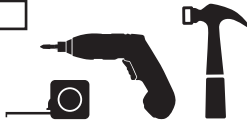

x12 3" (7,6 cm)
x2 3" (7,6 cm)
x27 2" (5,1 cm)

✓ BEGIN

- Center eave wall assembly on the floor.
- Use **OO** as a temporary brace. Secure with (2) 3" screws.

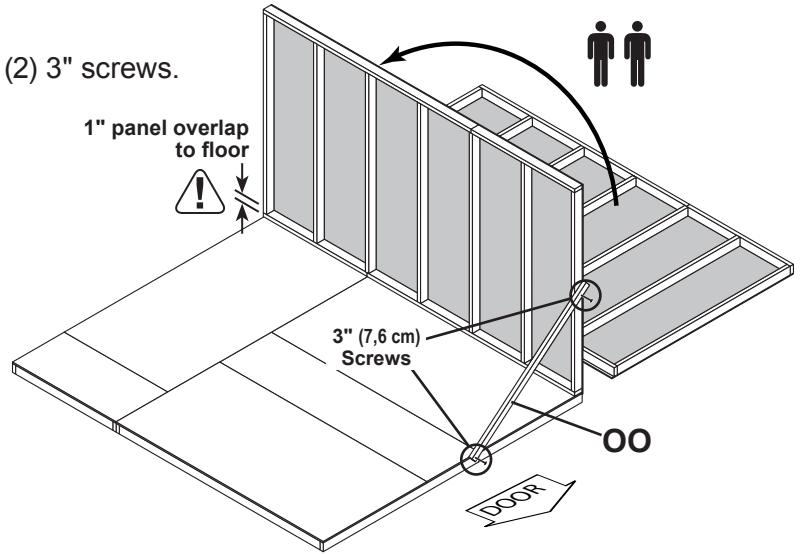

- Nail lower edge of panel to floor frame with 2" nails spaced 6" apart. Angle nails to hit floor frame (**Fig. A**).
- Secure bottom plates to floor with 3" nails (**Fig. A**).

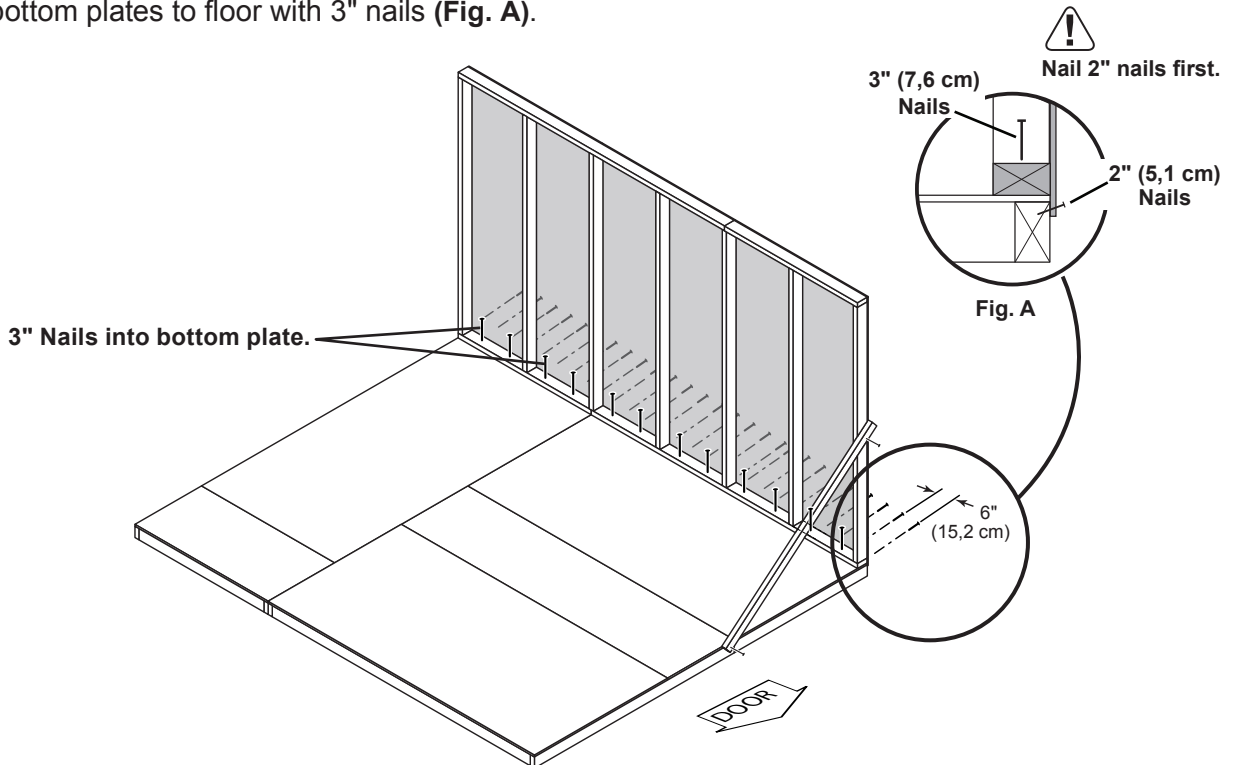

Your 12' eave wall is now installed.

10' GABLE END WALL INSTALLATION

PARTS REQUIRED:

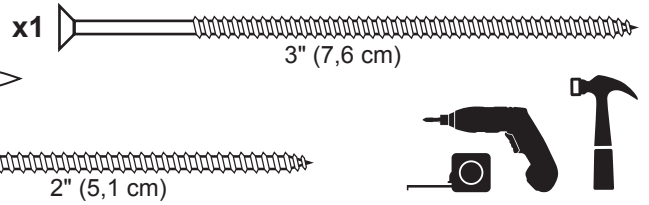
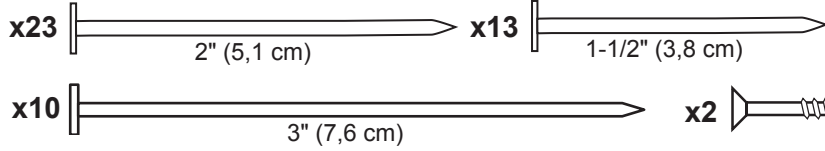

✓ **BEGIN**



1 Set gable end wall on floor and secure top of wall with (1) 2" screw into eave wall top plate (**Fig A**).

! ENSURE TOP OF WALL FRAMES ARE FLUSH.

2 Move to the bottom of gable end wall and secure bottom of wall with (1) 2" screw into eave wall bottom plate (**Fig A**).

Nail lower edge of panels to floor with 2" nails spaced 6" apart. Angle nails to hit floor frame (**Fig. B**).

! ENSURE GABLE AND BACK WALL PANELS ARE FLUSH BEFORE SECURING.

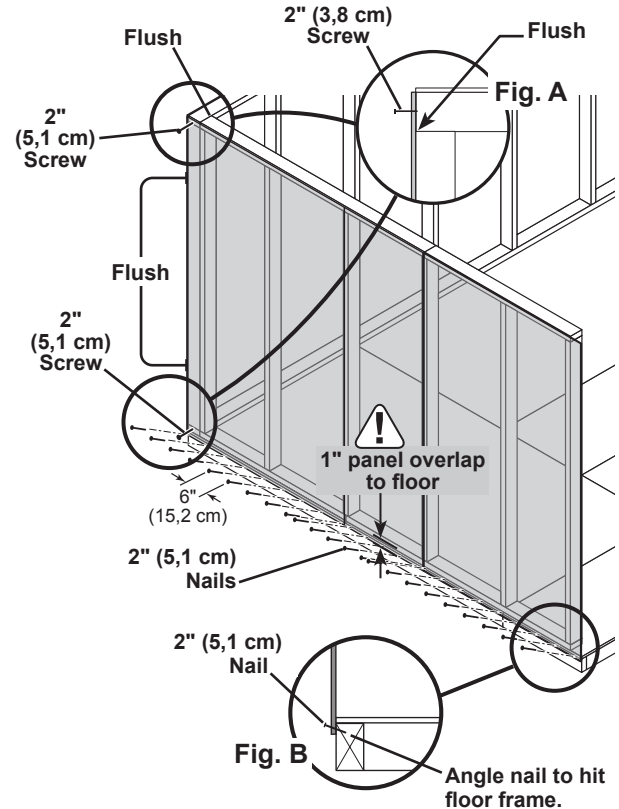

3 Nail gable wall panel to eave wall stud with 1-1/2" nails spaced 6" apart (**Fig. C**).

Secure gable wall to floor with 3" nails (**Fig. C**).

Secure gable wall top frame with (1) 3" screw angled into eave wall top plate as shown (**Fig. D**).

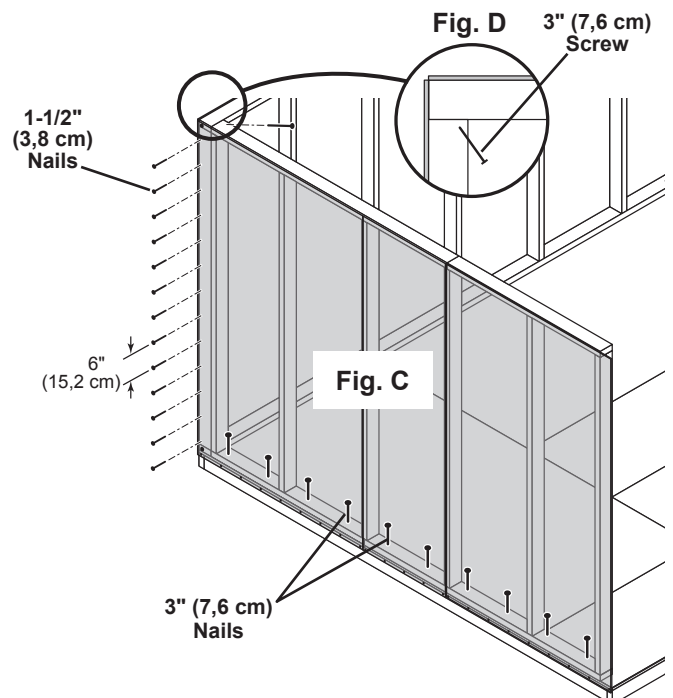

Your gable end wall is now installed

12' WINDOW WALL INSTALLATION

PARTS REQUIRED:

x1 **UN** TEMPORARY SUPPORT
2 x 4 x 94-1/2" (5,1 x 10,2 x 240 cm)

x2 2" (5,1 cm)

x3 3" (7,6 cm)

x13 1-1/2" (3,8 cm)



✓ BEGIN

- Center eave wall assembly on the floor.
Use UN as a temporary brace.
Secure with (2) 3" screws.

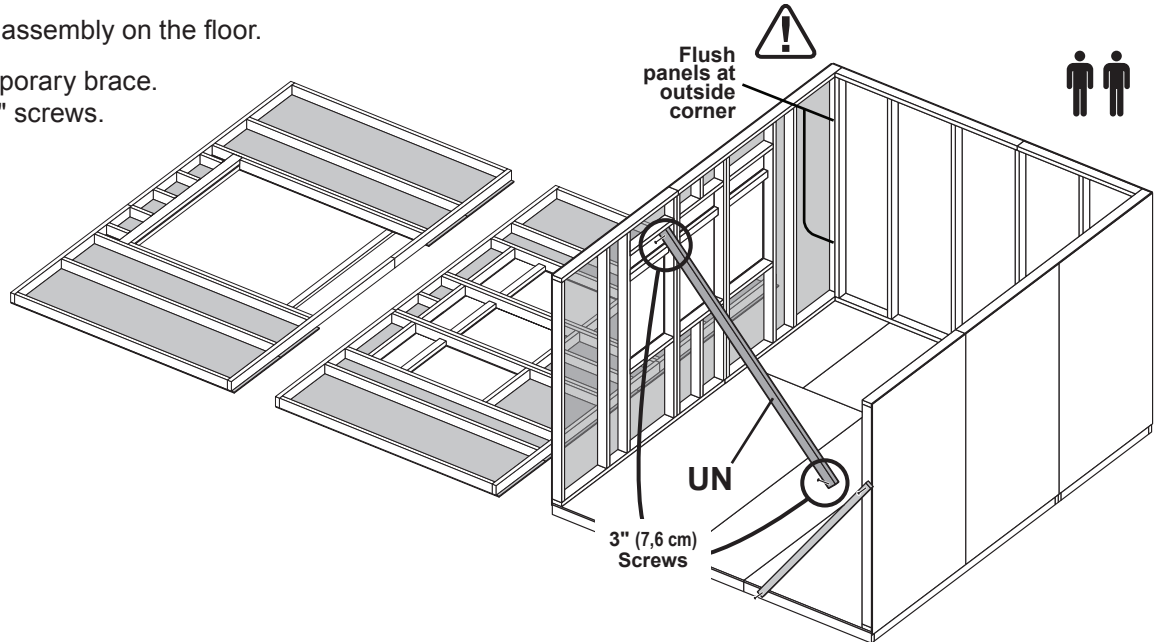

- Secure top of wall with (1) 2" screw into top plate (Fig A).

! BE SURE TOP OF WALL FRAMES ARE FLUSH.

Move to the bottom of gable end wall and secure bottom of wall with (1) 2" screw into eave wall bottom plate (Fig A).

Nail gable wall panel to front wall stud with 1-1/2" nails spaced 6" apart (Fig. B).

! ENSURE GABLE AND FRONT WALL PANELS ARE FLUSH BEFORE SECURING.

- Secure gable wall top plate with (1) 3" screw angled into eave wall top plate as shown (Fig. C).

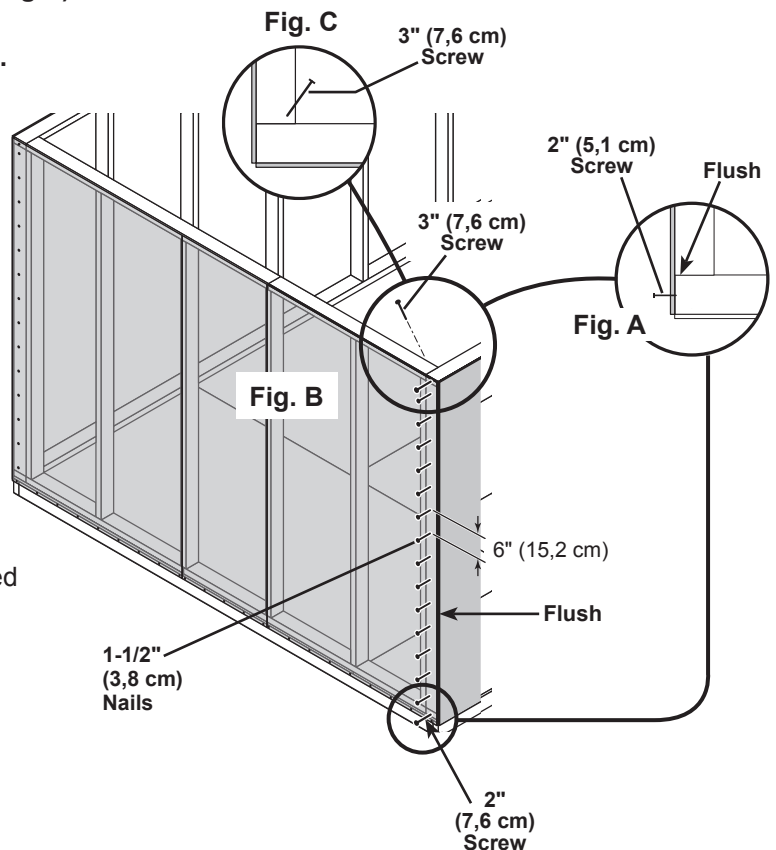

12' WINDOW WALL INSTALLATION

PARTS REQUIRED:

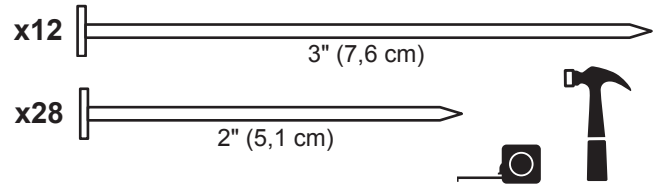

- 4 Nail lower edge of panels to floor frame with 2" nails spaced 6" apart.
Angle nails into floor frame (**Fig. D**).

Secure eave wall bottom plates to floor with 3" nails (**Fig. D**).

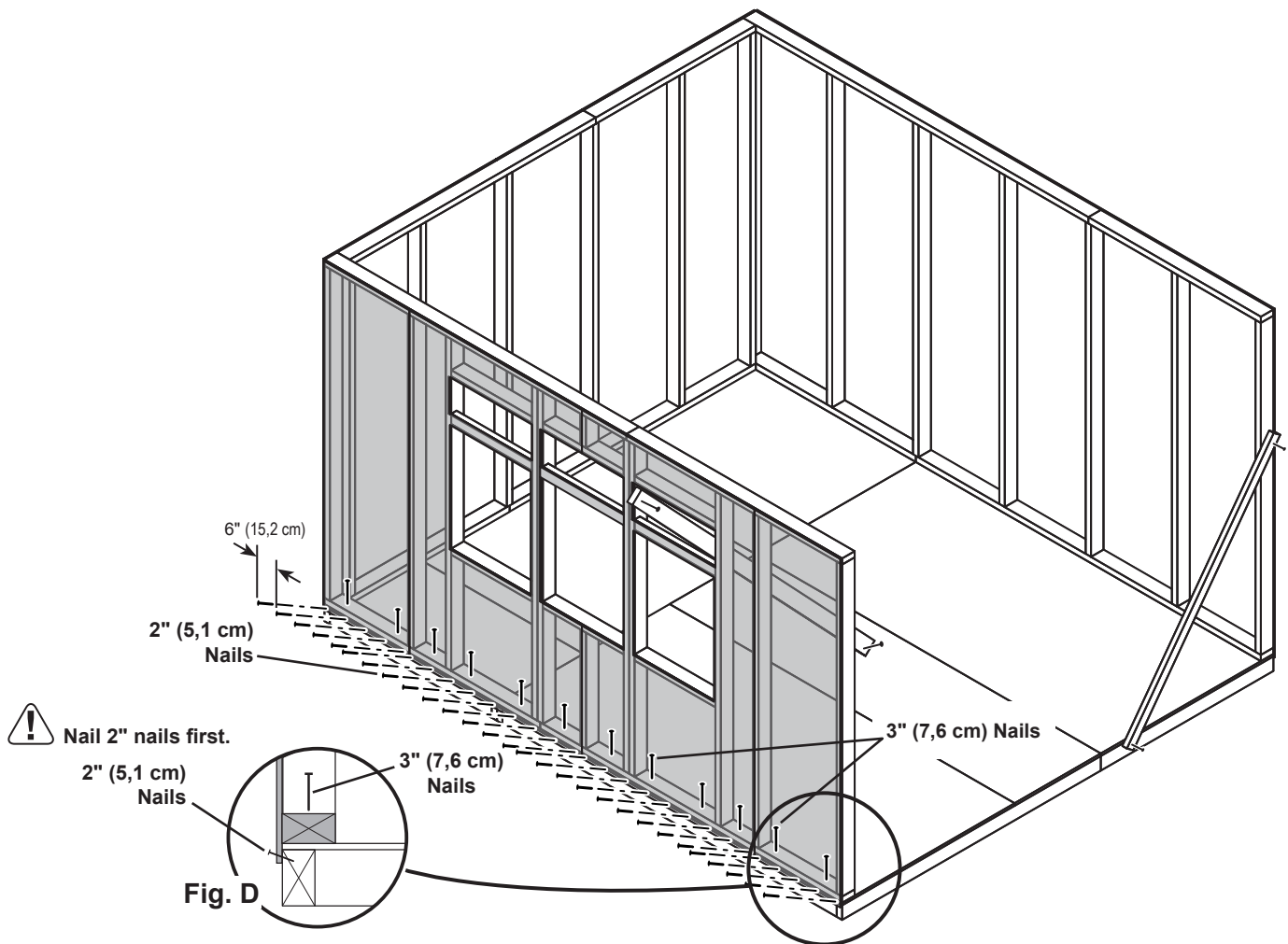

Your 12' eave wall is now installed.

10' DOOR WALL INSTALLATION

PARTS REQUIRED:

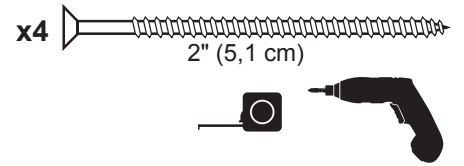

If your door is on the eave wall, install the gable wall with the windows.

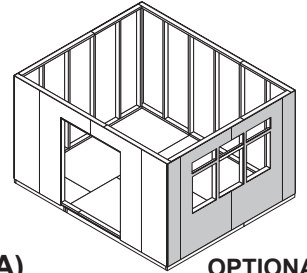

✓ **BEGIN**

- 1** Place 10' gable wall on floor.  Secure top of wall to eave wall top plates with (1) 2" screw at each side (**Fig A**).

 **ENSURE TOP WALL FRAMES ARE FLUSH.**

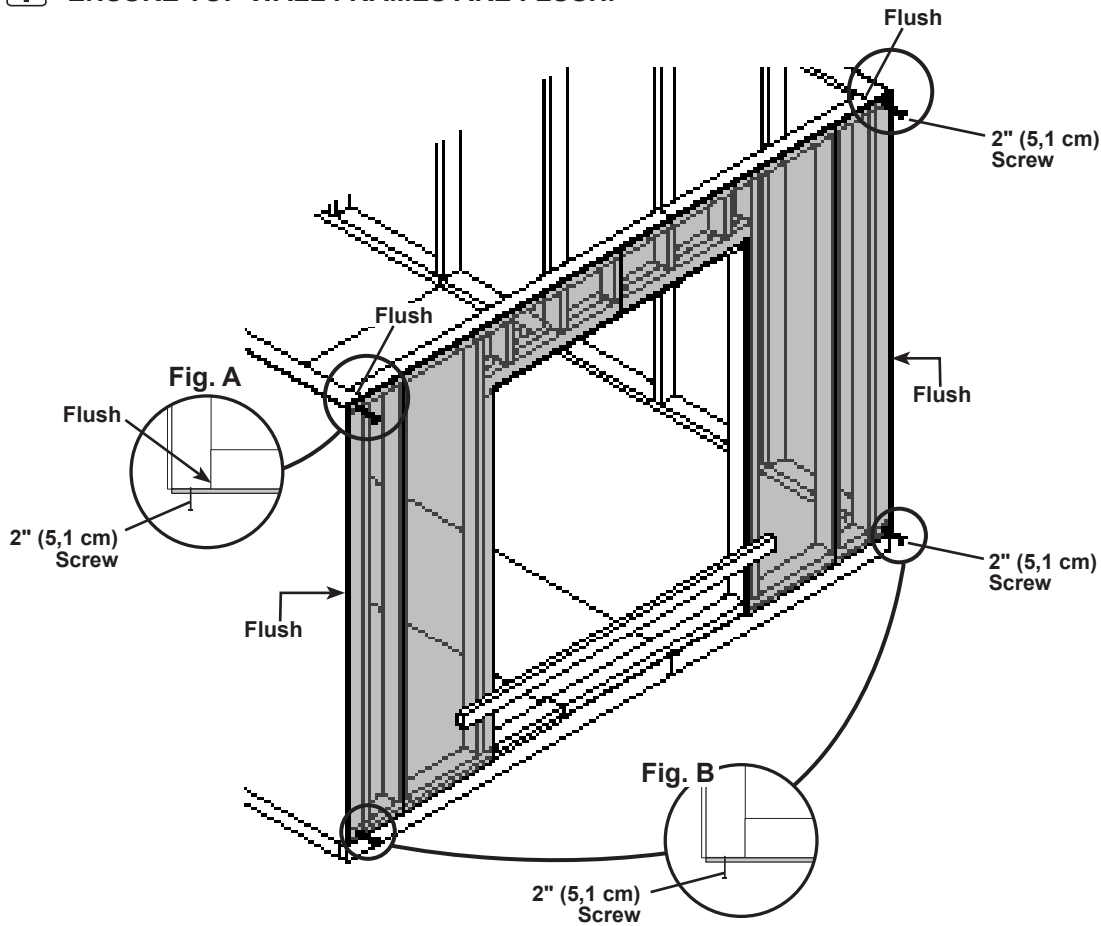



- 2** Secure bottom of wall to eave wall bottom plates with (1) 2" screw at each side (**Fig B**).

 **ENSURE WALL PANELS ARE FLUSH BEFORE SECURING.**

GABLE END WALL INSTALLATION

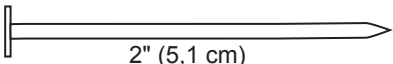
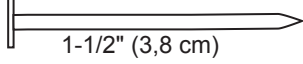
PARTS REQUIRED:

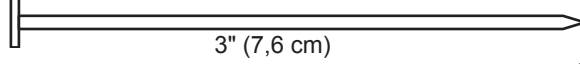
- x16  2" (5,1 cm)
- x26  1-1/2" (3,8 cm)
- x2  3" (7,6 cm)
- x6  3" (7,6 cm)



3 Nail lower edge of panels to floor with 2" nails spaced 6" apart. Angle nails into the floor frame (**Fig. C**).

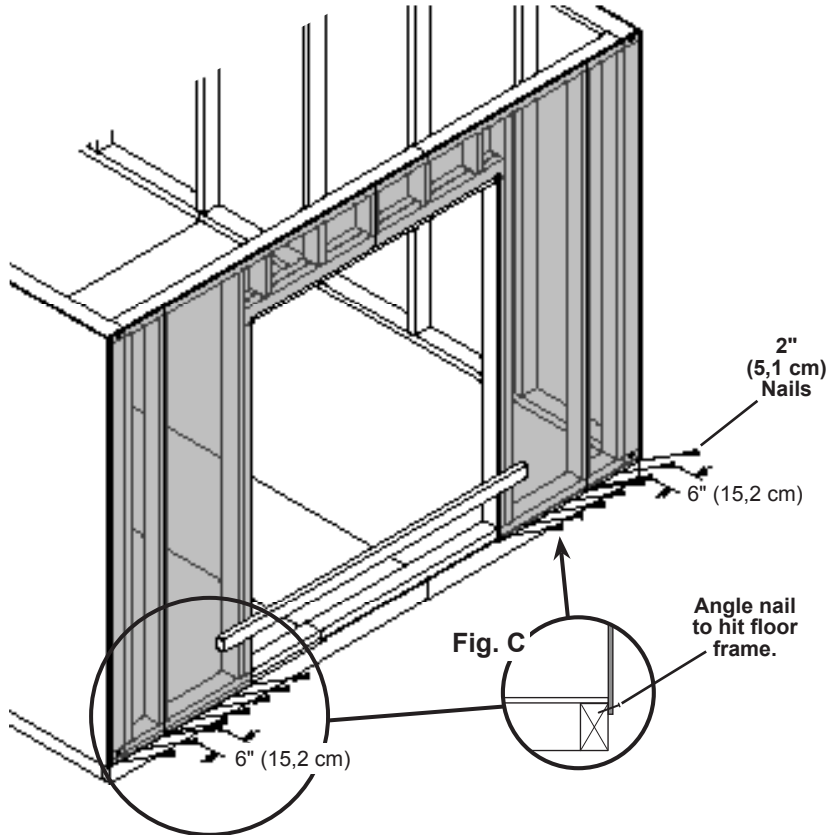

4 Nail gable wall panels to front and back wall studs with 1-1/2" nails spaced 6" apart (**Fig. E**).

Secure gable wall to floor with 3" nails (**Fig. E**).

Secure gable wall top plates with 3" screws angled into eave wall top plates at each side, as shown (**Fig. F**).

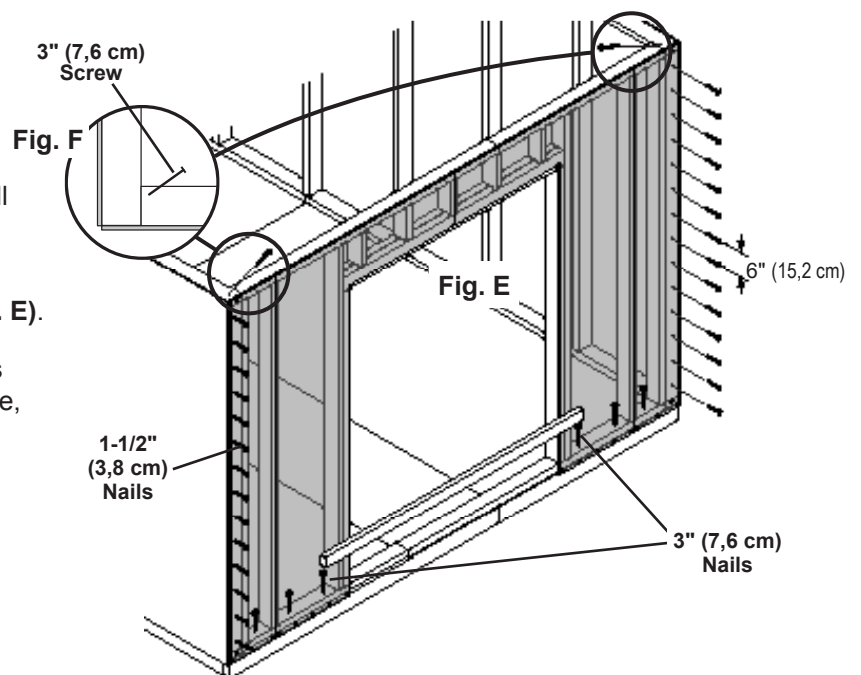

FINISH
Your gable wall is now installed.

**CUT OUT AND REMOVE BOTTOM PLATE AT
DOOR OPENING.**

Please continue to the included booklet

PART 2

to complete your shed.